

Serial Device Server

# CSE-M32 User Manual

Version 3.2



Sollae Systems Co., Ltd.

<https://www.ezTCP.com>



This symbol, found on your product or on its packaging, indicates that this product should not be treated as household waste when you wish to dispose of it. Instead, it should be handed over to an applicable collection point for the recycling of electrical and electronic equipment. By ensuring this product is disposed of correctly, you will help prevent potential negative consequences to the environment and human health, which could otherwise be caused by inappropriate disposal of this product. The recycling of materials will help to conserve natural resources. For more detailed information about the recycling of this product, please contact your local city office, household waste disposal service or the retail store where you purchased this product.

※ This equipment obtained certification by using 1.5M serial cable.

# Contents

<b>Contents</b> .....	<b>- 2 -</b>
<b>1 Overview</b> .....	<b>- 6 -</b>
1.1 Overview .....	- 6 -
<b>2 Specifications</b> .....	<b>- 7 -</b>
2.1 Components .....	- 7 -
2.2 Specifications .....	- 7 -
2.3 Interface .....	- 8 -
2.3.1 Dimension .....	- 8 -
2.3.2 JP1 .....	- 8 -
2.3.3 JP2 .....	- 9 -
2.3.4 DC Electric Characteristics .....	- 10 -
2.4 Serial Interface .....	- 10 -
2.4.1 Serial Type .....	- 10 -
2.4.2 Serial Baud rate .....	- 10 -
2.4.3 Data bits, Parity, and Stop bit .....	- 11 -
2.4.4 Flow Control .....	- 11 -
2.4.5 Telnet COM Port Control Option (RFC2217) .....	- 11 -
2.4.6 Disable TCP Transmission Delay .....	- 11 -
2.4.7 TX interval .....	- 11 -
2.4.8 TCP Server / Client mode .....	- 12 -
2.4.9 SPI Interface .....	- 12 -
2.5 Ethernet Interface .....	- 12 -
2.6 Application Circuits .....	- 12 -
2.6.1 RJ45 .....	- 12 -
2.6.2 Application circuit .....	- 0 -
<b>3 Test Run</b> .....	<b>- 0 -</b>
3.1 Test Run .....	- 0 -
3.1.1 Changing PC IP Address .....	- 0 -
3.1.2 Installing CSE-M32 .....	- 0 -
3.1.3 Configuring CSE-M32 .....	- 0 -
3.1.4 Communication Test .....	- 1 -
<b>4 Configuring IP Address and Variables</b> .....	<b>- 4 -</b>
4.1 IP Address and Environmental Variables .....	- 4 -

4.2	Configuration with ezManager.....	- 4 -
4.2.1	<i>ezManager</i> .....	- 4 -
4.2.2	<i>Buttons of ezManager</i> .....	- 5 -
4.2.3	<i>Parameters of ezManager</i> .....	- 5 -
4.2.4	<i>Matters to be attended to</i> .....	- 6 -
4.3	AT command.....	- 6 -
4.4	Notify IP Change.....	- 6 -
4.4.1	<i>DDNS (Dynamic Domain Name System)</i> .....	- 6 -
4.4.2	<i>TCP/UDP</i> .....	- 7 -
<b>5</b>	<b>Operation Mode .....</b>	<b>- 8 -</b>
5.1	Operation Mode Overview.....	- 8 -
5.1.1	<i>Overview</i> .....	- 8 -
5.2	How to Initiate Each Operation Mode .....	- 8 -
5.2.1	<i>Normal Mode</i> .....	- 8 -
5.2.2	<i>How to Initiate the Serial Configuration Mode</i> .....	- 8 -
5.2.3	<i>How to Initiate the ISP Mode</i> .....	- 8 -
5.2.4	<i>Comparison of Operation Modes</i> .....	- 8 -
5.3	Normal Communication Mode .....	- 9 -
5.4	Serial Configuration Mode .....	- 9 -
5.5	ISP Mode .....	- 10 -
5.5.1	<i>Upgrading Firmware</i> .....	- 10 -
<b>6</b>	<b>Normal Communication Mode .....</b>	<b>- 11 -</b>
6.1	T2S – TCP Server.....	- 11 -
6.1.1	<i>TCP Connection</i> .....	- 11 -
6.1.2	<i>Serial Data before the TCP Connection</i> .....	- 11 -
6.1.3	<i>Data Transmission</i> .....	- 11 -
6.1.4	<i>Disconnection</i> .....	- 12 -
6.2	COD – TCP Client.....	- 12 -
6.2.1	<i>Serial Data before the TCP Connection</i> .....	- 12 -
6.2.2	<i>Data Transmission</i> .....	- 13 -
6.2.3	<i>Disconnection</i> .....	- 13 -
6.2.4	<i>DNS</i> .....	- 13 -
6.3	ATC.....	- 14 -
6.3.1	<i>Key parameters</i> .....	- 14 -
6.3.2	<i>Examples</i> .....	- 15 -
6.4	UDP .....	- 18 -
6.4.1	<i>Key parameters</i> .....	- 18 -

6.4.2	Examples.....	- 19 -
<b>7</b>	<b>Security Protocols &amp; Option .....</b>	<b>- 21 -</b>
7.1	SSL .....	- 21 -
7.1.1	SSL (Secure Socket Layer).....	- 21 -
7.1.2	How to set the SSL on CSE-M32.....	- 21 -
7.1.3	Restriction.....	- 22 -
7.2	SSH.....	- 22 -
7.2.1	SSH (Secure Shell).....	- 22 -
7.2.2	How to set the SSH on CSE-M32.....	- 22 -
7.2.3	Restriction.....	- 23 -
7.3	ezTCP Firewall.....	- 23 -
<b>8</b>	<b>Checking &amp; Debugging.....</b>	<b>- 25 -</b>
8.1	Telnet .....	- 25 -
8.1.1	Telnet Login.....	- 25 -
8.1.2	Commands.....	- 25 -
8.2	Status on ezManager .....	- 27 -
8.2.1	Status of the CSE-M32.....	- 27 -
8.2.2	Closing TCP connection by the ezManager.....	- 27 -
8.3	Remote Debugging.....	- 28 -
<b>9</b>	<b>The Evaluation Board.....</b>	<b>- 29 -</b>
9.1	Introduction .....	- 29 -
9.2	Connectors.....	- 29 -
9.3	Jumpers and Switches .....	- 30 -
9.3.1	JP5.....	- 30 -
9.3.2	JP9, JP10.....	- 30 -
9.3.3	Reset Switch (S1).....	- 30 -
9.4	System LEDs classified each mode.....	- 31 -
9.5	Schematic of the evaluation board .....	- 0 -
<b>10</b>	<b>Related material.....</b>	<b>- 0 -</b>
10.1	Technical Documents .....	- 0 -
10.2	Smart phone application.....	- 0 -
<b>11</b>	<b>Technical Support and Warranty.....</b>	<b>- 1 -</b>
11.1	Technical Support .....	- 1 -
11.2	Warranty.....	- 1 -
11.2.1	Refund.....	- 1 -

11.2.2 Free Repair Services .....	- 1 -
11.2.3 Charged Repair Services.....	- 1 -
<b>12 Precaution and Exemption from Liability .....</b>	<b>- 2 -</b>
12.1 Precaution.....	- 2 -
12.2 Exemption from Liability.....	- 3 -
12.2.1 English version.....	- 3 -
12.2.2 French version.....	- 3 -
<b>13 Revision History.....</b>	<b>- 6 -</b>



# 1 Overview

## 1.1 Overview

Along with the development of the Internet, the demand for data communication functions has increased recently. Data communication over the Internet requires using TCP/IP, the Internet communication protocol. That is to say, in order to connect a system to the Internet, TCP/IP protocol must be implemented. It is possible to implement TCP/IP by directly implementing the protocol, porting open TCP/IP in public or using Operating System (OS). However, all these methods impose burdens on the developer in time, cost, and technology.

ezTCP series, a Serial ↔ TCP/IP protocol converter product group of Sollae Systems, enables you to use TCP/IP communication (the Internet communication) function simply by "connecting the cable to a serial port". ezTCP sends data from the serial port to the Internet network after TCP/IP processing, and vice versa.

CSE-M32 in ezTCP product group is a product that provides TCP/IP communication through Ethernet. In other words, like other ezTCP products, CSE-M32 sends data from the serial ports to the LAN after TCP/IP processing and vice versa.

As CSE-M32 has 2 UART ports so that it supplies TCP/IP functions to two UART devices. And because one UART port support the TCP speed of about 1.8Mbps, CSE-M32 is very useful for the high speed communication device.

It provides DHCP and PPPoE functions, so that it can be applied to the cable network and the xDSL network. And it has DDNS (Dynamic DNS) function, so it can be used more easily in the internet.

It also provides debugging function, so user can solve the problem with ours.

## 2 Specifications

### 2.1 Components

- CSE-M32 Body
- Evaluation Board (Optional)
- 5V SMPS Adapter (Optional)
- RS232C cable for PC connection – DB9F-DB9M-2M (Optional)

### 2.2 Specifications

Power	Input Voltage	3.3V ( $\pm 10\%$ )
	Current	230mA typical
Dimension	50mm x 32mm x 9mm	
Weight	About 9g	
Serial Port	2 x UART, 3.3V level with 5V tolerant input 300bps ~ 1843200bps (COM2 port is disabled when COM1 is 1843200bps) RTS/CTS flow control	
Network	Ethernet 10Base-T or 100Base-TX (Auto-Sensing) Auto MDI/MDIX	
Protocols	TCP, UDP, IP, ICMP, ARP, DHCP, PPPoE, Telnet, DNS Lookup, DDNS, Telnet COM Port Control Option(RFC2217), SSL, SSH	
Diagnostic	Online Debugging Function	
Temperature	Operating: 0 ~ 55°C, Storage: -40 ~ 85°C	
RoHS	RoHS Compliant	
Communication Mode	T2S	TCP Server Mode
	COD	TCP Client Mode
	ATC	TCP Server/Client (AT command emulation)
	U2S	UDP
Utilities	ezManager	Configuration utility via LAN
	ezterm	Socket test utility
	hotflash	Firmware download utility via TFTP
	ezVSP	Serial-TCP/IP virtual driver for Windows



## 2.3 Interface

### 2.3.1 Dimension

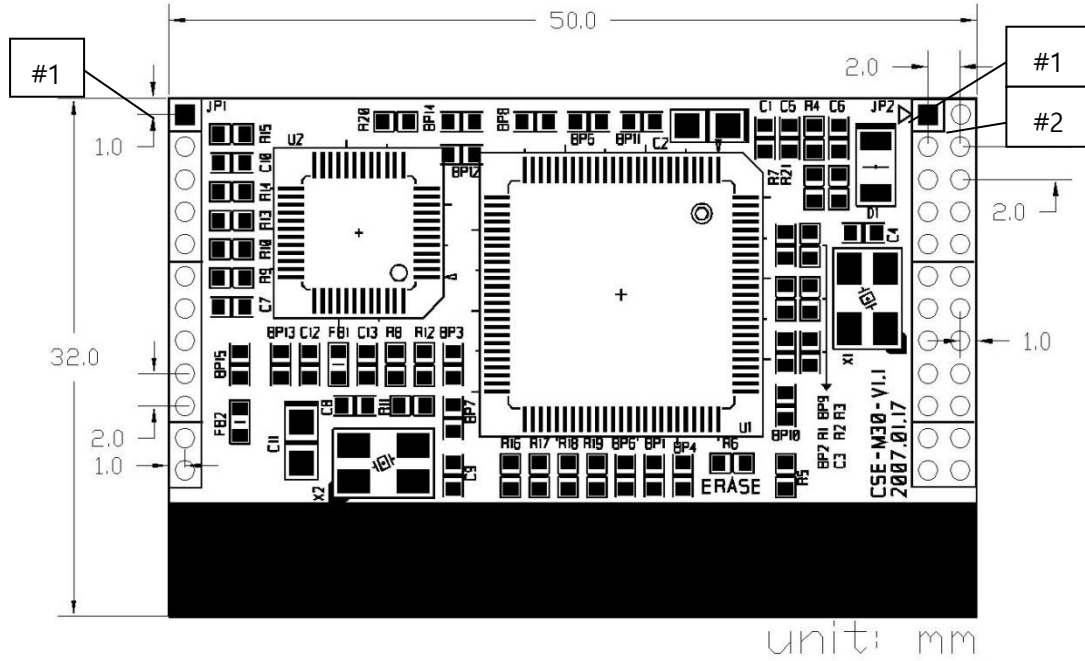

### 2.3.2 JP1

M: Mandatory

O: Optional

JP1	name	description	Dir.	Etc.
1	GND	Ground	-	M
2	TP_IN-	Ethernet In-	In	M
3	TP_IN+	Ethernet In+	In	M
4	PWFBOU	PWFBOU	In	M
5	TP_OUT-	Ethernet Out-	Out	M
6	TP_OUT+	Ethernet Out+	Out	M
7	GND	Ground	-	M
8	LAN_RXD-	LAN RXD LED- Blink: There are data on Ethernet line	Out	O
9	LAN_TXD-	LAN TXD LED- Blink: CSE-M32 transmits data to Ethernet port	Out	O
10	LINK-	Link LED- CSE-M32 is being connected to a LAN	Out	O
11	STS-	Status LED-	Out	O
12	VCC_33	VCC 3.3V	-	M

### 2.3.3 JP2

M: Mandatory

O: Optional

X: Don't Connect

JP2	name	description	Dir.	Etc.
1	GND	Ground	-	M
2	VCC_33	VCC 3.3V	-	M
3	SPI_NSS	SPI NSS SPI Chip Select	In	N/A
4	SYS_RST-	Reset-	In/Out	O
5	SPI_MISO	SPI MISO (Master In Slave Out)	Out	N/A
6	CN0-	TCP Connection 0 Status- Low-UART0's TCP connection is established	Out	O
7	SPI_MOSI	SPI MOSI (Master Out Slave In)	In	N/A
8	CN1-	TCP Connection 1 Status- Low-UART1's TCP connection is established	Out	O
9	SPI_SCK	SPI SCK SPI Serial clock	In	N/A
10	ISP-	ISP- If this pin is low when it boots up, it operates as ISP Mode (internally pulled-up). If this pin is low for 20ms~1000ms, CSE-M32 enters to the serial configure mode.	In	O
11	GND	Ground	-	M
12	GND	Ground	-	M
13	UART_TXD1	UART1 (COM2) Transmitting Port	Out	O
14	UART_TXD0	UART0 (COM1) Transmitting Port	Out	O
15	UART_RTS1	UART1 (COM2) RTS UART1 (COM2) TXDE (RS485 Mode)	Out	O
16	UART_RTS0	UART0 (COM1) RTS UART0 (COM1) TXDE (RS485 Mode)	Out	O
17	DTXD	Port for factory	Out	X
18	GND	Ground	-	M
19	UART_RXD1	UART1 (COM2) Receiving Port	In	O
20	UART_RXD0	UART0 (COM1) Receiving Port	In	O

21	UART_CTS1	UART1 (COM2) CTS	In	O
22	UART_CTS0	UART0 (COM1) CTS	In	O
23	DRXD	Port for factory	In	X
24	GND	Ground	-	M

### 2.3.4 DC Electric Characteristics

The followings are the DC electric Characteristics of the each pin.

Symbol	Min	Max	Unit
$V_{IL}$	-0.3	0.8	V
$V_{IH}$	2.0	5.5	V
$V_{OL}$		0.4	V
$V_{OH}$	$VCC_{33} - 0.4$		V

## 2.4 Serial Interface

There are two serial ports in CSE-M32. Each port can be configured independently.

### 2.4.1 Serial Type

User can set RS232, RS422 and RS485 to CSE-M32's serial port. If CSE-M32 is configured as RS485, the RTS pin operates as TXDE for RS485 line driver. (The TXDE is Low when CSE-M32 doesn't send data to its serial port and High when CSE-M32 sends data to its serial port.)

### 2.4.2 Serial Baud rate

The following is configurable Baud rate table.

COM1	COM2	Etc.
300	300	
600	600	
1200	1200	
2400	2400	
4800	4800	
9600	9600	
14400	14400	
19200	19200	
38400	38400	
57600	57600	

115200	115200	
230400	230400	
460800	460800	
921600	921600	
1843200	-	If COM1 is set as 1843200, COM2 is disabled.

The maximum Baud rate of COM1 is 1,843,200bsp, and the maximum Baud rate of COM2 is 921,600bps. If COM1 is set as 1,843,200bps (its maximum Baud rate), the COM2 port is disabled. (unavailable)

### 2.4.3 Data bits, Parity, and Stop bit

Item	Configurable Value
Data bit	8, 7, 6, 5
Parity	None, Even, Odd, Mark, Space
Stop bit	1, 1.5, 2

### 2.4.4 Flow Control

CSE-M32 support RTS/CTS Hardware Flow Control. RTS pin is for notifying connected serial devices that its buffer can be available to receive data. CTS pin is for checking that the RTS signal of its counterpart. To use this control CSE-M32 should be set to the type of serial communication is RS232.

### 2.4.5 Telnet COM Port Control Option (RFC2217)

CSE-M32 has Telnet COM Port Control Option function that is specified by RFC2217. If the Telnet COM Port Control Option is enabled, CSE-M32 sends the CTS control signal to the communication counterpart, and CSE-M32 sets its serial port items (RTS, baud rate, data bits, parity, stop bit) after getting information from the communication counterpart.

### 2.4.6 Disable TCP Transmission Delay

If you use this option, CSE-M32 sends the data from the serial port to Ethernet as quickly as possible.

### 2.4.7 TX interval

This option is for preventing data loss in the case that the serial device has very small buffer size or doesn't have a buffer. The range of the value could be from 0 to 25 and the unit is duration of sending 1 byte. For example, if you set this value to 5, each byte will be transferred with duration of sending 5 bytes.

### 2.4.8 TCP Server / Client mode

This mode is available on TCP client mode only. In this mode, you don't need to change the mode for switching active or passive TCP connection. Note that the [Event Byte] option should be set to 1 or larger value.

### 2.4.9 SPI Interface

CSE-M32 doesn't support SPI interface.

## 2.5 Ethernet Interface

The Ethernet port has 10M/100M auto sense function and auto MDI/MDIX function. User has to add additional circuit (a pulse-transformer and a RJ45) for Ethernet. Refer to the following Application Circuits that we recommend you.

## 2.6 Application Circuits

### 2.6.1 RJ45

The RJ45 connector in this circuit embeds a pulse-transformer.

The followings are the recommended lists.

Part	Manufacturer	Description
RDA-126BAG1A (old: RD1-126BAG1A)	UDE	With LEDs
RDA-106BAG1A (old: RD1-106BAG1A)	UDE	Without LEDs
LU1S041XLF	Both hand	Without LEDs

## 2.6.2 Application circuit

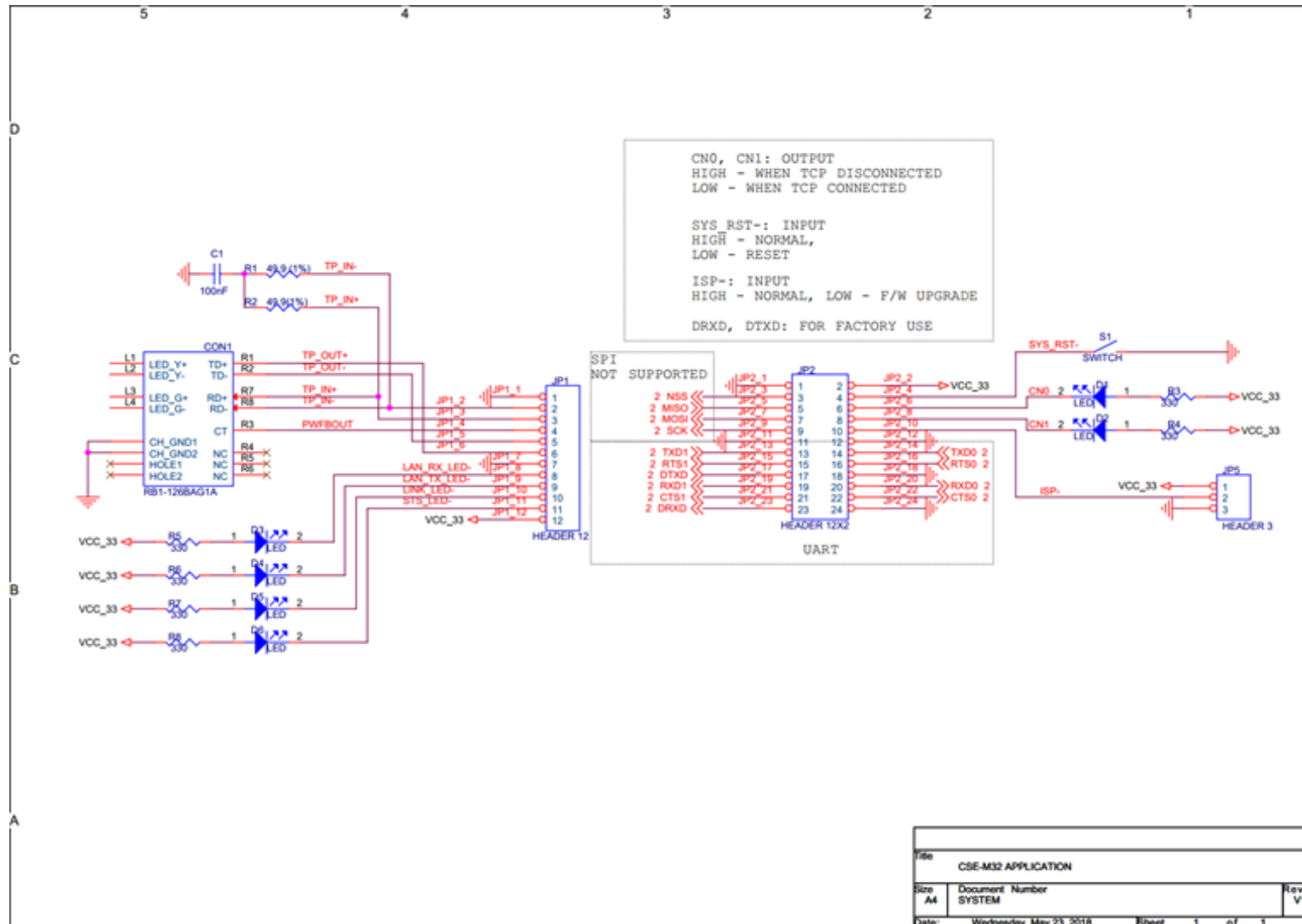

## 3 Test Run

### 3.1 Test Run

You can perform test run according to the following orders. The test run described here is based on the assumption that the IP address of the PC is set to 10.1.0.2

#### 3.1.1 Changing PC IP Address

You can change the IP address of your PC as follows:

IP Address	10.1.0.2
Subnet Mask	255.0.0.0
Gateway IP Address	-

#### 3.1.2 Installing CSE-M32

Insert the CSE-M32 to its evaluation board. Connect the offered RS232 cable (RJ45-DB9F-1M) between your PC and the evaluation board, the LAN cable to the hub which the PC is connected or directly to the PC, and the connect the power adapter to CSE-M32 evaluation board inserting electric outlet for power supply. If the LAN cable has been correctly connected when power is supplied, LINK LED will be turned on.

#### 3.1.3 Configuring CSE-M32

Configure CSE-M32 setting using ezManager, the ezTCP configuration program, as follows.

Run ezManager, and click [Search All] button in the ezManager window. And, ezManager program will search all ezTCP including CSE-M32 on the local network.

When CSE-M32 is found, MAC address of the ezTCP is displayed on the [Search Results] window (The MAC address is indicated on the body).

Select the corresponding MAC address, and set the variables considering your network environment.

When no ezTCP is found, check the Windows firewall. If you press [Windows Firewall] button in the ezManager, you can see the Windows Firewall menu directly.

For simple test, we recommend that the variables keep default values as shown in the below table.

Parameter		Value
Network	Local IP Address	10.1.0.1
	Subnet Mask	255.0.0.0
Option	Telnet	Enabled
	IP Address Search	Enabled
Serial Port (COM1/2)	Serial Type	RS232
	Baud Rate	19200bps
	Parity	NONE
	Data Bits	8
	Stop Bit	1
	Flow	NONE
	Communication Mode	T2S – TCP Server
	Local Port	1470/1471

### 3.1.4 Communication Test

Power the CSE-M32 off and on, then it tries to connect to the LAN.

- A program for testing starts if you press the [Simple Test] button of the ezManager.

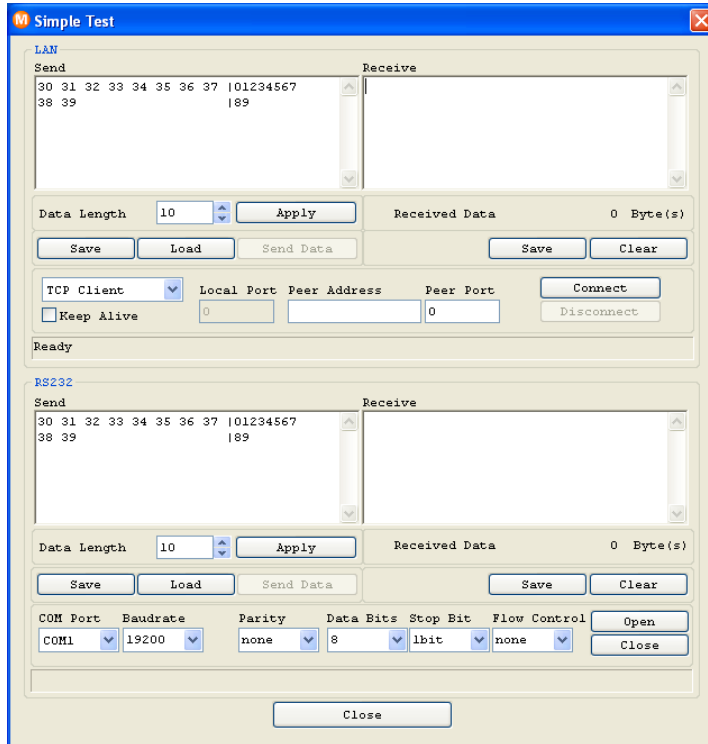



- Press the [Connect] button after inputting 10.1.0.1 and 1470 in the IP and Port. If the TCP connection is established there will be "Connected [ 10.1.0.1 : 1470 ]." And the STS indicator will be on.

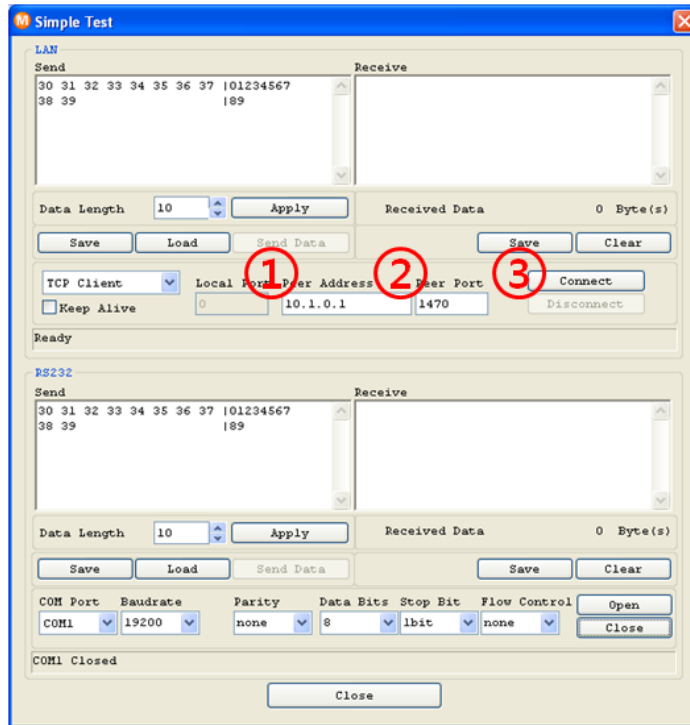

- Press the [Open] button after selecting serial port that is connected to the CSE-M32. If the serial port is open, the "COM1 the COM port has opened" message will be shown.

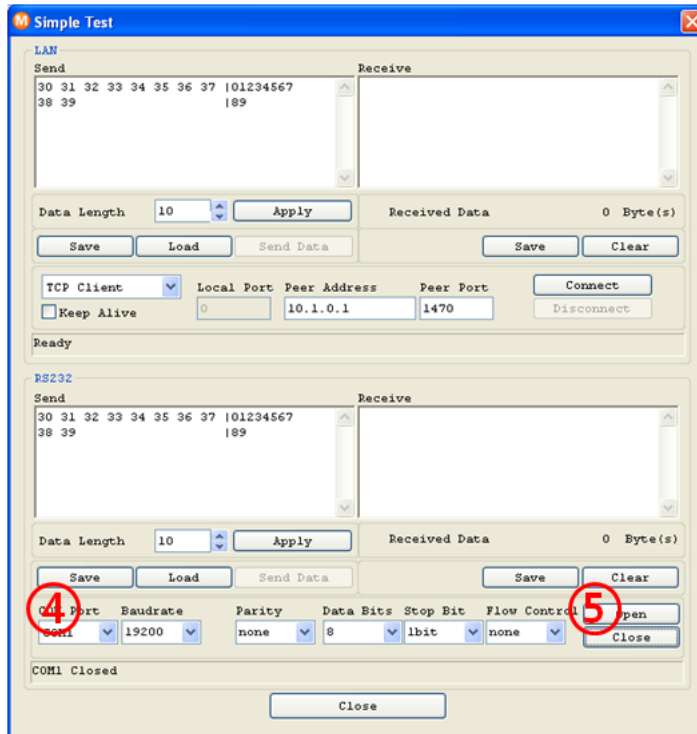

- If you press the [Send Data] button on the LAN part (Top), the data shown in the [Send] box will be transmitted to the [Receive] box on the RS232 part (Bottom).

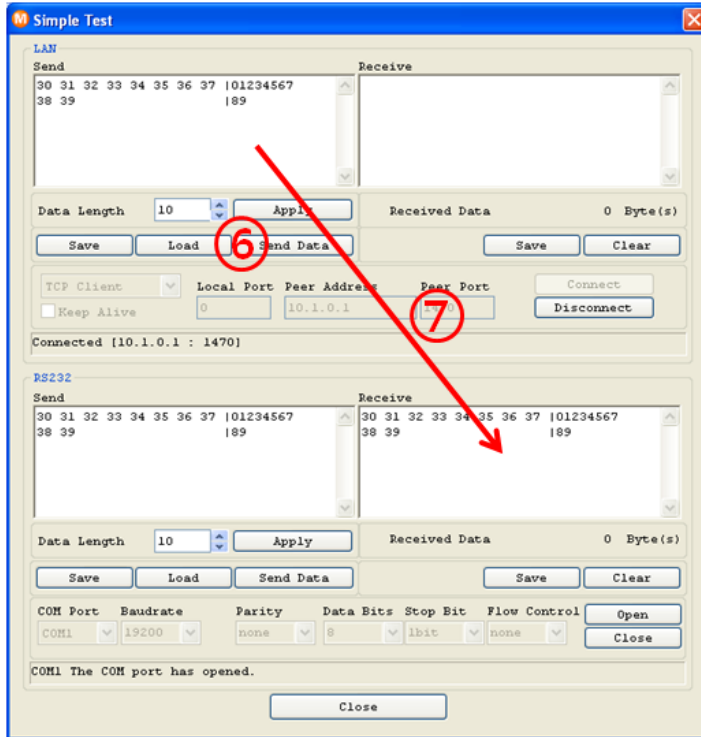

- If you press the [Send Data] button on the RS232 part (Bottom), the data shown in the [Send] box will be transmitted to the [Receive] box on the LAN part.

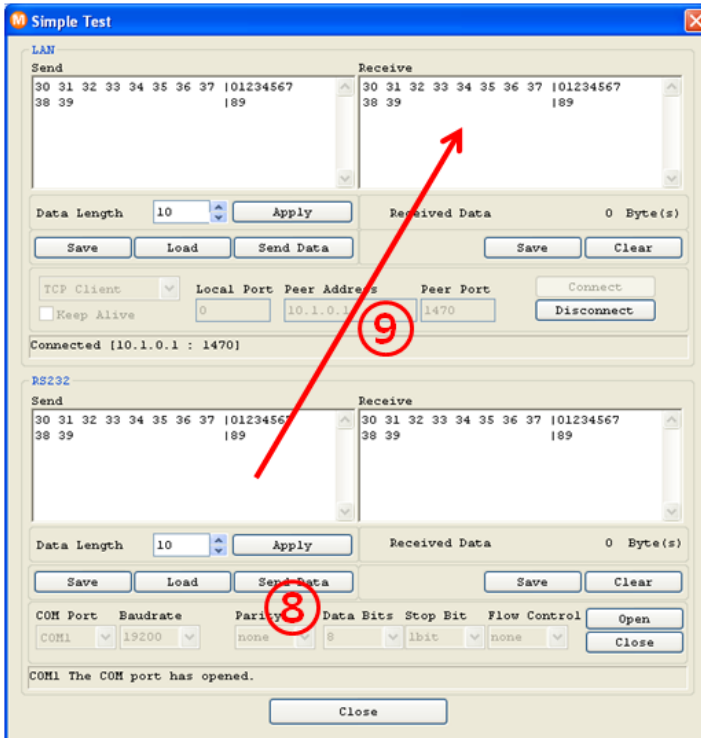

- If the transmitting and receiving data are same, the communication test is successful.

## 4 Configuring IP Address and Variables

### 4.1 IP Address and Environmental Variables

For TCP/IP communication, you must set IP address related items. In addition, you have to set serial port related items (serial port type, communication speed, data bit length, parity bit, flow control, etc) to CSE-M32.

You can set the IP address and the serial port related items by using ezManager, the supplied configuration utility which allows you to configure your CSE-M32 over the network, or by using AT commands in ATC mode.

### 4.2 Configuration with ezManager

#### 4.2.1 ezManager

The basic environmental variables (IP address related items, serial port items, and etc.) can be set by ezManager which is an integrated management tool for Windows.

ezManager is operated in Microsoft Windows(Windows 2000 Pro, ME, XP Pro/Home, Vista, 7). Following is the screen shot of ezManager which is just launched.

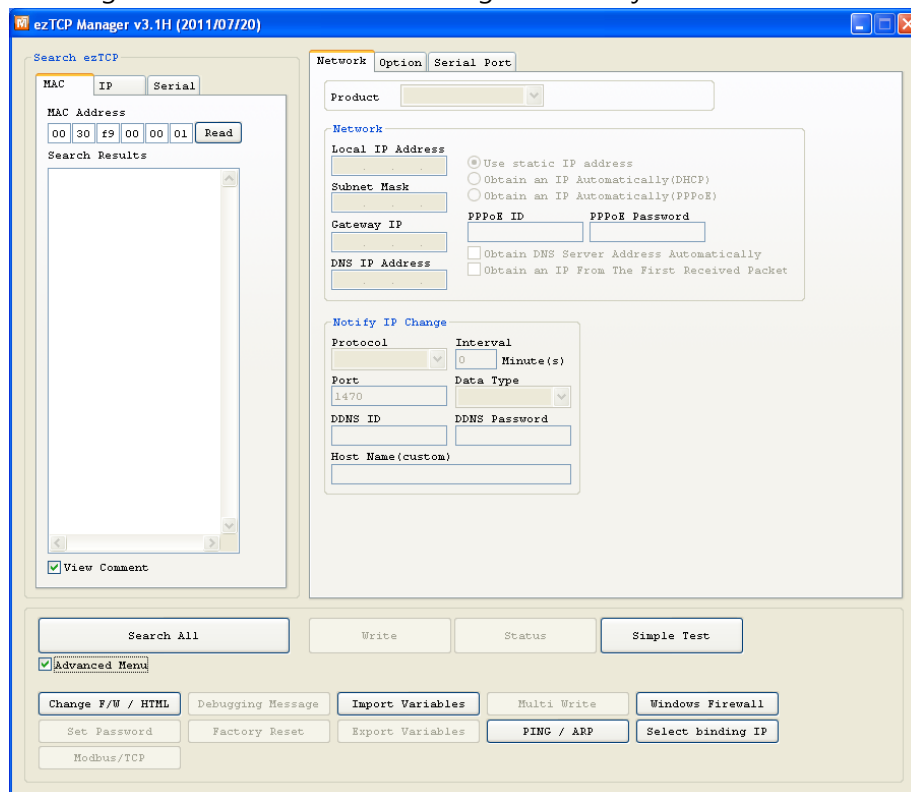

*ezManager communicates UDP broadcast and its UDP ports are 50005 and 50006. Port number 50005 is for setting and port number 50006 is for debugging. If you use any firewall function, the ports have to be opened.*

#### 4.2.2 Buttons of ezManager

Button	Description
Read	Read the values configured through MAC or IP address.
Write	Store the changed values of parameters
Set Password	Set or remove the password by this button.
Status	Check the status of ezTCP in real time.
Factory Reset	Initialize all the values as a default.
Debugging Message	Make the ezTCP broadcast debugging messages.
Change F/W / HTML	Change the firmware or HTML files with this button.
Export Variables	Store a set of values as a file.
Import Variables	Load values from a file made from [Export Variables]
Multi Write	Configure a set of values to one or more ezTCP
PING/ARP	Test the PING reply and manage the ARP table.
Simple Test	Run the test program interfaced with Network and RS232 port.
Windows Firewall	Run the windows firewall set window.
Exit	Exit ezManager

#### 4.2.3 Parameters of ezManager

Tap	Section	Parameters
Network	Network	Local IP Address, Subnet Mask, Gateway IP, DNS IP Address
	Notify IP Change	Protocol, Interval, Port, Data Type, DDNS ID, DDNS Password, Host Name(dyndns/custom)
	Option	Obtain an IP From The First Received Packet, Obtain an IP Automatically (DHCP), Obtain an IP Automatically (PPPoE), PPPoE ID, PPPoE Password, Obtain DNS Server Address Automatically
Option	Option	Telnet, IP Address Search, Send MAC Address, Debugging Message, SSL, SSH, Multiple Connection
	ezTCP Firewall	Allowed MAC Address, Allowed IP Range, IP Address, Network Mask, Apply To ezManager
Serial Port	Serial Port	Serial Type, TTL, Baud Rate, Parity, Data Bits, Stop Bit, Flow Control, DTR/DSR, TX Interval

	TCP/IP	Communication Mode, Peer Address, Peer Port, Local Port, Event Byte, Timeout, Data Frame
--	--------	------------------------------------------------------------------------------------------------

#### 4.2.4 Matters to be attended to

ezManager can be used when you want to change your device's environment variables. In case of CSE-M32, two interfaces are supported and those are Ethernet and RS232 port.

- Using Ethernet Port

For use ezManager through Ethernet, CSE-M32 should be connected with PC on networks. If they are located at the same network, [Search All], on the [MAC] tap, could be used with MAC address. If they are connected on Internet, [Read], on the [IP] tap, could be used.

- Using RS232 Port

For use ezManager through RS232, not only the CSE-M32 should be connected to PC with RS232 cross cable but also has to be operated as serial configuration mode.

### 4.3 AT command

In ATC mode, the user can set environment variables through the serial port using AT command.

*☞ For more information, See "6.3 ATC Mode".*

### 4.4 Notify IP Change

In internet environment, most host get IP addresses dynamically. In this case, it is very hard to communicate to the host because the IP address is changed dynamically. The IP Change Trap service solves this problem. There are 3 types- DDNS, TCP and UDP- for this service.

#### 4.4.1 DDNS (Dynamic Domain Name System)

If the CSE-M32 obtains its IP address, it notices to the service provider. Then the service provider serves DNS service. So, even though user doesn't know the CSE-M32's IP address, user can connect to the CSE-M32 by the host name (after DNS looking up.) The DDNS service provider that the CSE-M32 supports is only DynDNS (<https://dyn.com/dns/>) currently.

*☞ All about service usage of an account could be changed according to the policy of DynDNS.*

#### 4.4.2 TCP/UDP

In addition, CSE-M32 can transmit some information to user's TCP/UDP servers each period which is set. This information is IP address, MAC address, product ID, firmware version, and comment. The data can be sent as either ASCII or Hexadecimal type.

☞ *For more details about the Notify IP Change, please refer to the document on our web site.*

☞ *For more details about the ezManager, please refer to the manual of ezManager on our web site.*



## 5 Operation Mode

### 5.1 Operation Mode Overview

#### 5.1.1 Overview

CSE-M32 can operate in one of three modes (normal, serial configuration and ISP modes). Normal mode is ordinary data communication mode; and serial configuration mode is a configuration mode through the serial port; and ISP mode is used to download CSE-M32 firmware through the Ethernet port.

### 5.2 How to Initiate Each Operation Mode

#### 5.2.1 Normal Mode

Normal mode is a mode in which CSE-M32 performs its original functions. If the ISP- pin keeps High, CSE-M32 is operated in this mode.

*☞ For more information, see "6. Normal Communication Mode."*

#### 5.2.2 How to Initiate the Serial Configuration Mode

Inputting low signal to the ISP- pin from 20ms to 1000ms, CSE-M32 works in the serial configuration mode.

#### 5.2.3 How to Initiate the ISP Mode

The CSE-M32 checks its ISP- pin when it boots up. If the ISP- pin is High it operates as Normal Mode and if ISP- pin is Low it operates as ISP mode that is firmware download mode. So user has to pull down the ISP- port for ISP mode.

The ISP- pin is pulled up internally. So it operates as Normal Mode if the pin is open.

#### 5.2.4 Comparison of Operation Modes

The following table is the comparison of the above described operation modes.

Mode	How to Initiate	Description	Serial Port Communication Speed
Normal	ISP- pin open or Pull-up	Normal data communication mode T2S, ATC, COD, U2S	User setting
Serial Configuration	ISP- pin to Low for 20ms ~ 1000ms	Configuring the environmental variables through the serial	115200bps,N,8,1 Using the COM1 port

		port.(COM1)	
ISP	ISP- pin pull-down	Download firmware through the Ethernet port All security functions are disabled	115200bps,N,8,1 Using the COM1 port

### 5.3 Normal Communication Mode

Normal communication mode is suitable for the purpose of using CSE-M32.

Normal communication mode can be classified into four modes – T2S, ATC, COD, and U2S – each of which is described in the following table.

Communication Mode	Protocol	Connection	Need for User Equipment Software Modification	Configuration of Environmental Variables through Serial Port	Topology
T2S	TCP	Passive Connection	Not needed	Impossible	1:1
ATC	TCP	Active /Passive Connection	Needed	Possible	1:1
COD	TCP	Active Connection	Not needed	Impossible	1:1
U2S	UDP	No Connection	Not needed	Impossible	N:M

TCP protocol requires connection process. The connection is always established as 1:1 connection. At this time, the host waiting for connection (passive connection) is called a server and the one attempting to connect (active connection) is called a client.

On the other hand, UDP communicates by block unit without connection process. As UDP does not require connection, numbers of hosts can communicate at the same time.

### 5.4 Serial Configuration Mode

This mode is for configuration under condition which the network is unavailable. When entering this mode, parameters of CSE-M32 can be set by its COM1 port. [Serial] tap on the ezManager let users do this.





## 5.5 ISP Mode

### 5.5.1 Upgrading Firmware

In ISP mode, you can download a firmware (CSE-M32 operation software) provided by our company. There is another thing in this mode. If you forget your password set before, you can reset it by entering this mode. In ISP mode, all the security options including ezTCP firewall are removal.

The following is the firmware downloading procedure.

- Supply power with ISP- pin low, then CSE-M32 operates in the ISP mode.
- Run hotflash that is supplied by us and input IP address of CSE-M32 and select the firmware with the [FILE] menu. Then, send it with [SEND] button. (Uncheck the [Verify firmware version] option.)

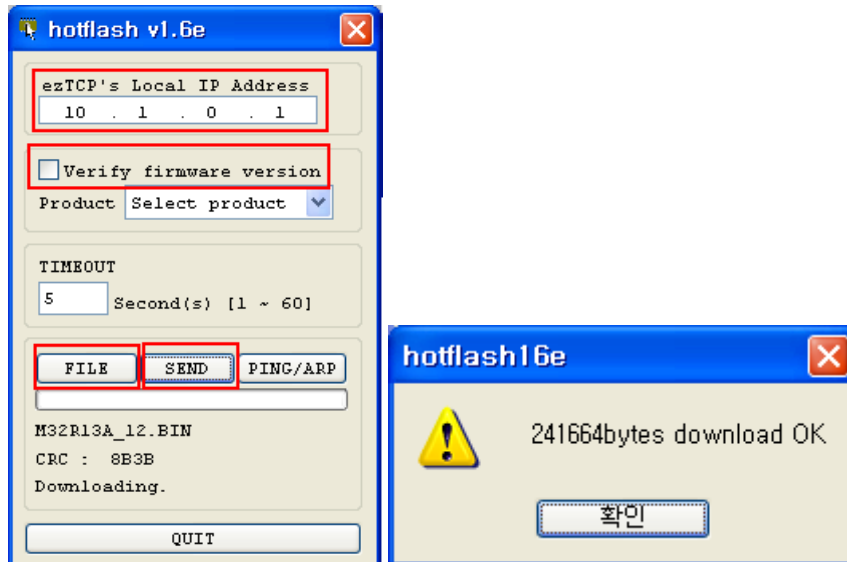

- When the downloading is completed, set the ISP- pin to High and reset it in order to enter normal mode again.

☞ ***Firmware download can be implemented with ezManager whose version is 3.0A or subsequent version.***

## 6 Normal Communication Mode

### 6.1 T2S – TCP Server

In T2S mode, the CSE-M32 functions as a server.

When a host connects to predefined local port, the CSE-M32 accepts a TCP connection. When the ezTCP accepts TCP connection, then the TCP connection is established. After connection is established, TCP/IP processing is performed on the data coming to the serial port, which is then transmitted to the remote host. And the TCP/IP data coming from the remote host is TCP/IP-processed and transmitted to the serial port to establish data communication.

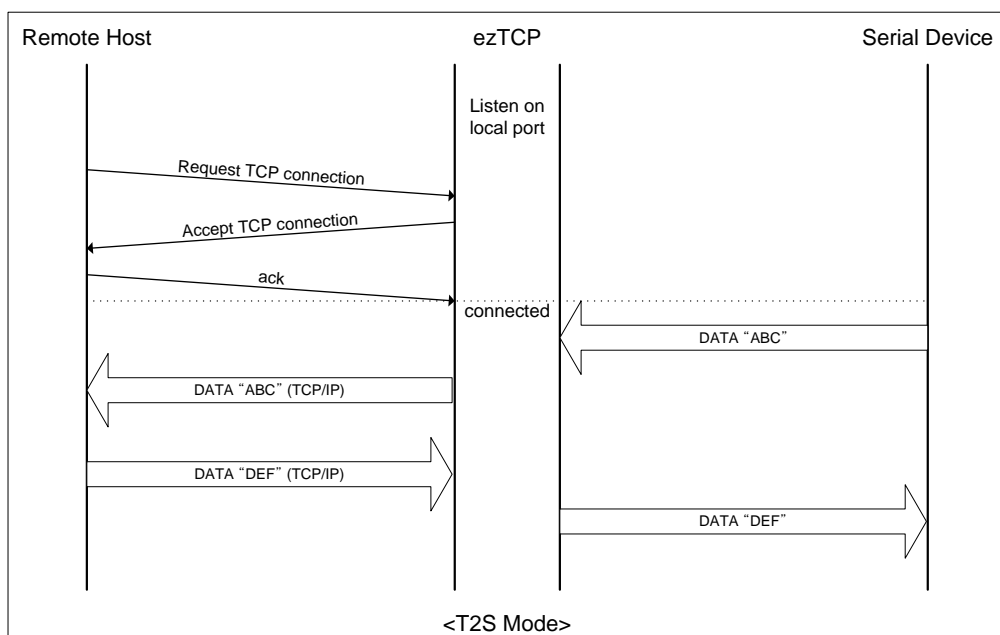

#### 6.1.1 TCP Connection

If a host connects to the pre-defined [Local Port] of CSE-M32, the host can communicate bi-directionally.

#### 6.1.2 Serial Data before the TCP Connection

The received serial data before the TCP connection is established will be handled based on the [Event Byte] settings. If the [Event Byte] is 0, the data that comes to serial port of CSE-M32 will not be recognized. If it is not 0, the serial data before TCP connection will be temporarily saved to be sent to the host after the connection.

#### 6.1.3 Data Transmission

When the TCP connection is established, the data communication in between the host and the serial device will be established. Then, CSE-M32 will send data according to the [Data Frame]. In other words, when the data comes through CSE-M32's serial port, it will be

temporarily saved in the buffer. Then, when there is no incoming data during the designated [Data Frame], CSE-M32 will send the saved data. If the [Data Frame] is 0, CSE-M32 will send serial port's data immediately. The unit used for the [Data Frame] is 10m seconds, so CSE-M32 rounds down rest of the values.

### 6.1.4 Disconnection

When the connected host terminates the connection, or there is no data communication during the designated [Timeout], the TCP connection will be automatically terminated. The unit used for [Timeout] is 1 second.

## 6.2 COD – TCP Client

In COD mode, the ezTCP functions as a client.

When data of the pre-specified size [Event Byte] comes to the serial port, the ezTCP attempts a TCP connection to the TCP port [Peer Port] of the preset host IP [Peer IP Address]. If the remote host accepts the TCP connection, TCP connection will be established. Data coming to the serial port after connection establishment is TCP/IP-processed and transmitted to the remote host. And, data coming from the remote host is TCP/IP-processed and transmitted to the serial port for data communication.

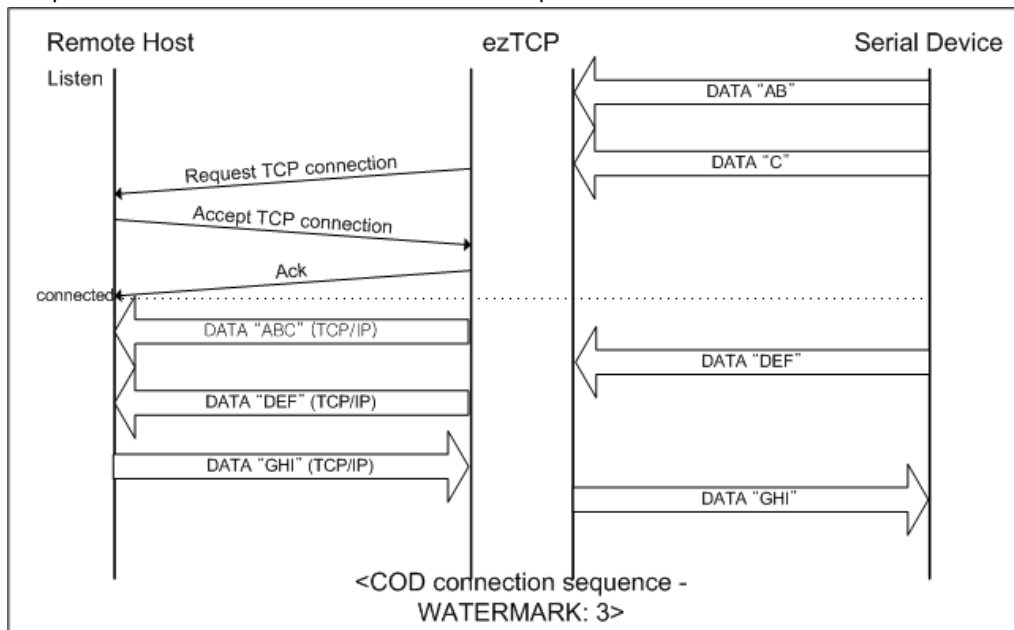

### 6.2.1 Serial Data before the TCP Connection

Data before TCP connection will be handled based on the [Event Byte] settings. If the [Event Byte] is 0, the data that comes to CSE-M32's serial port will not be recognized. If it is not 0, the serial data before TCP connection will be temporarily saved to be sent to the host after the connection.

### 6.2.2 Data Transmission

When the TCP connection is established, the data communication in between the host and the serial device will be established. Then, CSE-M32 will send data according to the [Data Frame]. In other words, when the data comes through CSE-M32's serial port, it will be temporarily saved in the buffer. Then, when there is no incoming data during the designated [Data Frame], CSE-M32 will send the saved data. If the [Data Frame] is 0, CSE-M32 will send serial port's data immediately. The unit used for the [Data Frame] is 10 milliseconds, so CSE-M32 rounds down rest of the values.

### 6.2.3 Disconnection

When the connected host terminates the connection, or there is no data communication during the designated [Timeout], the TCP connection will be automatically terminated. The unit used for [Timeout] is 1 second.

### 6.2.4 DNS

If users set the host name instead of the IP address on the [Peer Address] box, CSE-M32 query the IP address of the host to its Domain Name Server (DNS). The IP address of DNS can be configured on ezManager. If you set incorrect address on that box, the connection won't be established.

## 6.3 ATC

AT command is a mode which users control CSE-M32 with AT command like controlling modem. In this mode, active and passive TCP connections are available. And users are allowed to configure some environmental parameters with extended commands.

### 6.3.1 Key parameters

The configuration should be implemented via the serial port of CSE-M32.

Table 6-1 some of extended commands for configuration

Commands	Description	Examples
+PLIP	Local IP Address	at+plip=10.1.0.1 <CR>
+PLP	Local Port	at+plp=1470<CR>
+PRIP	Peer IP Address	at+prip=10.1.0.2 <CR>
+PRP	Peer Port	at+prp=1470<CR>
+PDC	DHCP	at+pdc=1 (ON)<CR>
+PPE	PPPoE	at+ppe=1 (ON)<CR>
+PTO	Timeout	at+pto=10<CR>
+PWP	Store setting	at+pwp<CR>

- Related items with IP Address and Local Port
  - Local port can be set as well as IP address related parameters like IP Address, Subnet Mask and Gateway IP Address.
- Peer Address / Peer Port
  - IP address and local port of a remote host are can be set.
- Type of assigning IP address: Manual, DHCP, PPPoE
  - Not only manual setting, also automatic assigning protocol (DHCP, PPPoE) are available.
- Others
  - Some of options including [Timeout] can be configured in this mode.

### 6.3.2 Examples

- TCP Server – setting parameters and passive connection

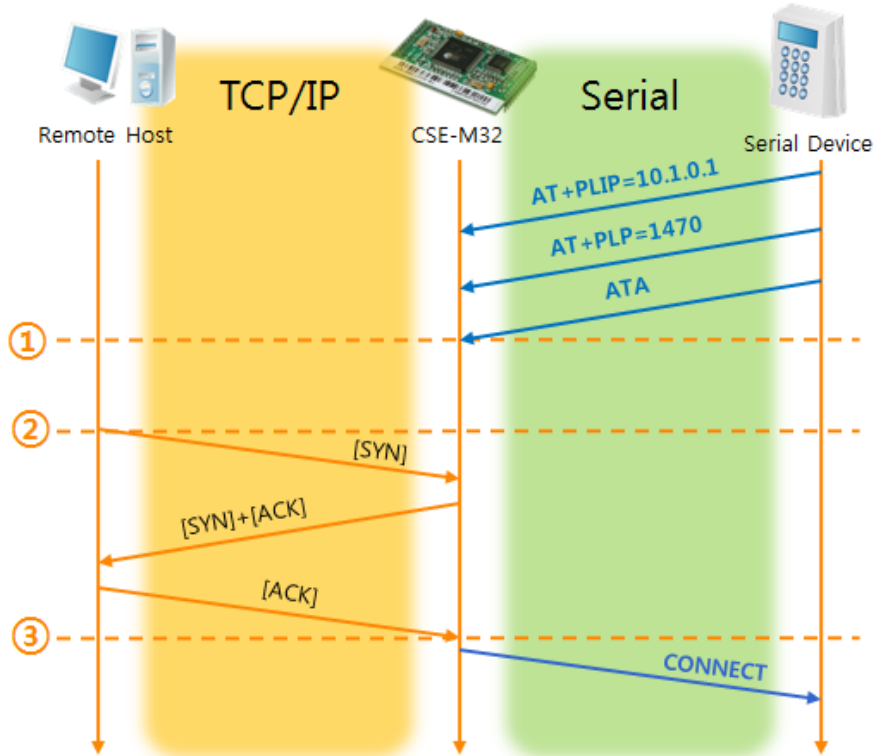

Figure 6-1 TCP passive connection

Table 6-2 states of each point

Points	States
~	Set parameters in the AT command mode
①	CSE-M32 listens TCP connection requests with the ATA command
~	CSE-M32 is listening TCP connection requests
②	A remote host has sent SYN segment to CSE-M32
~	Processes of TCP connection
③	TCP connection has been established
~	CSE-M32 sends "CONNECT" message to the serial port

☞ **Most of the response messages from the serial port of CSE-M32 are omitted on above figure.**

- TCP Client – setting parameters and active connection

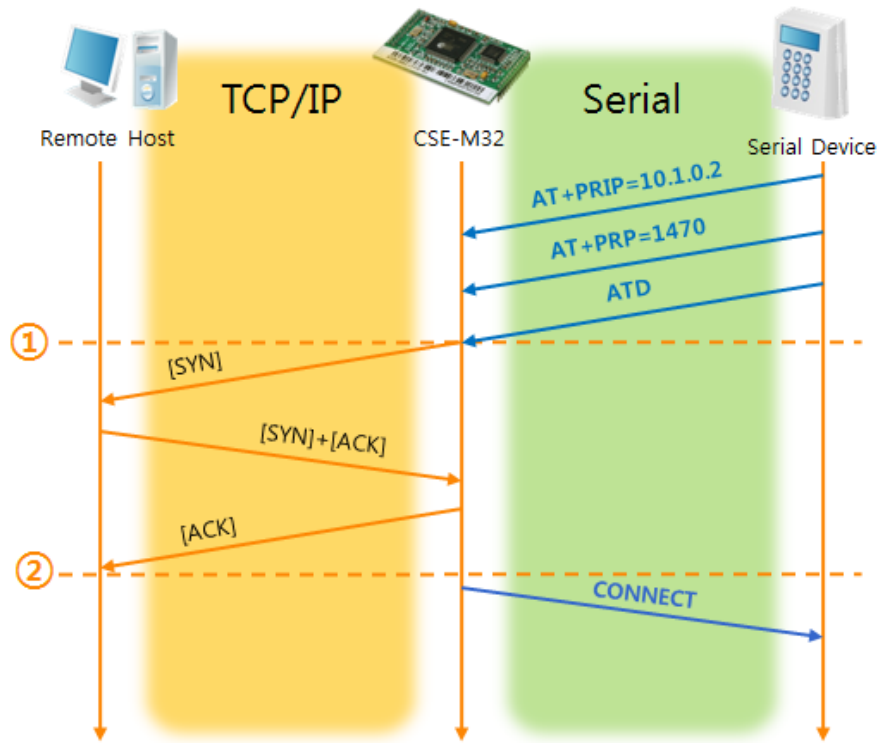

Figure 6-2 TCP Active connection

Table 6-3 states of each point

Points	States
~	Set parameters in the AT command mode
①	CSE-M32 sends a TCP connection request with the ATD command
~	Processes of TCP connection
②	TCP connection has been established
~	CSE-M32 sends "CONNECT" message to the serial port

- Termination of online status – entering the AT command mode

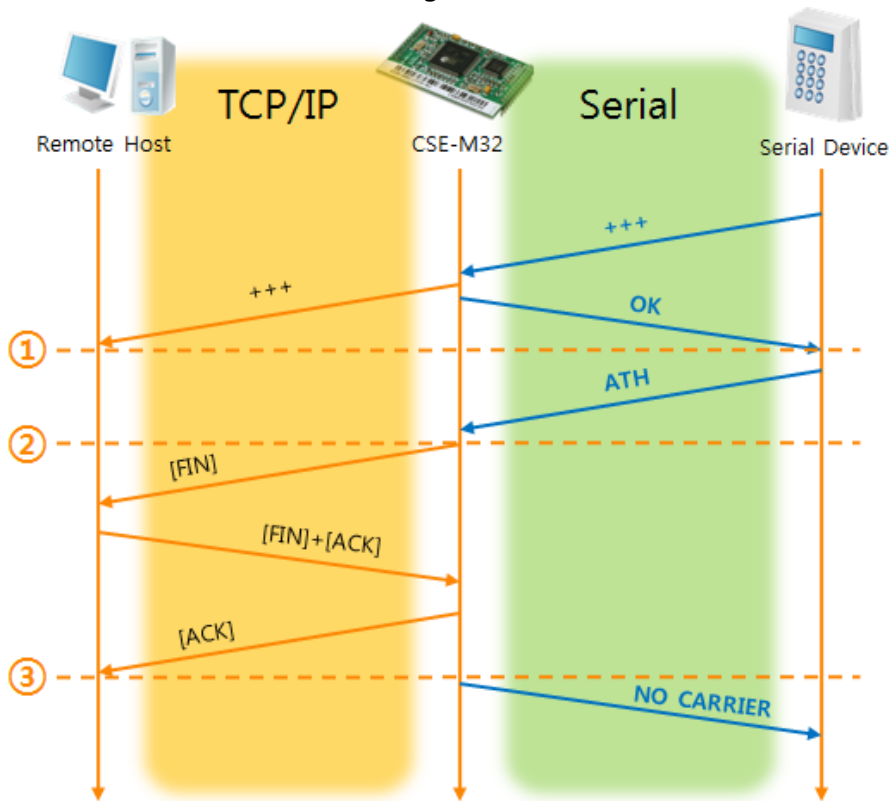

Figure 6-3 Termination of online status

Table 6-4 states of each point

Points	States
~	Keeps TCP connection
①	CSE-M32 enters the AT command mode with receiving "+++"
~	Keeps AC command mode
②	CSE-M32 terminates TCP connection with ATH command
~	Processes of TCP disconnection
③	TCP connection has been terminated
~	CSE-M32 sends "NO CARRIER" with disconnection

CSE-M32 changes the mode to AT command, when receiving "+++" and sending "OK" message. In this state, the communication with remote host is not possible because CSE-M32 processes only AT command. Whenever you want to go back to online state (TCP connection), use "ATO" command.

*☞ For more information about this, please refer to the "ATC mode" on the [Download] >> [Technical Document] menu of our web site.*



## 6.4 UDP

UDP has no processes of connection. In this mode, data is sent in block units. Therefore, data that comes through CSE-M32's serial port must be classified in block units to send it elsewhere.

### 6.4.1 Key parameters

- Block Size(Byte)

[Block Size(Byte)] means the size of a block in UDP mode. Its unit is byte. The size of bytes are come into the serial port, CSE-M32 sends them as one block to the network. The maximum value could be 1460 bytes.

- Data Frame

[Data Frame] means the time for gathering data to make one block. Its unit is 10ms. If there are no transmission during the time which is set to this value, CSE-M32 sends gathered data in the buffer as one block to the network.

☞ ***Please set this value to 11 or higher values for correct operation.***

☞ ***Once one of the parameters is sufficient, the block size is decided as the condition.***

- Dynamic update of Peer host

If users set the value of [Peer Address] and [Peer Port] to 0, [dynamic update of peer host] function is activated. By using this function, CSE-M32 can communicate to multiple hosts without additional setting.

☞ ***This function is available on 1.2H or subsequently released firmware version.***

### 6.4.2 Examples

- Block Size: 5 bytes / Data Frame: 1s (100 by 10ms)

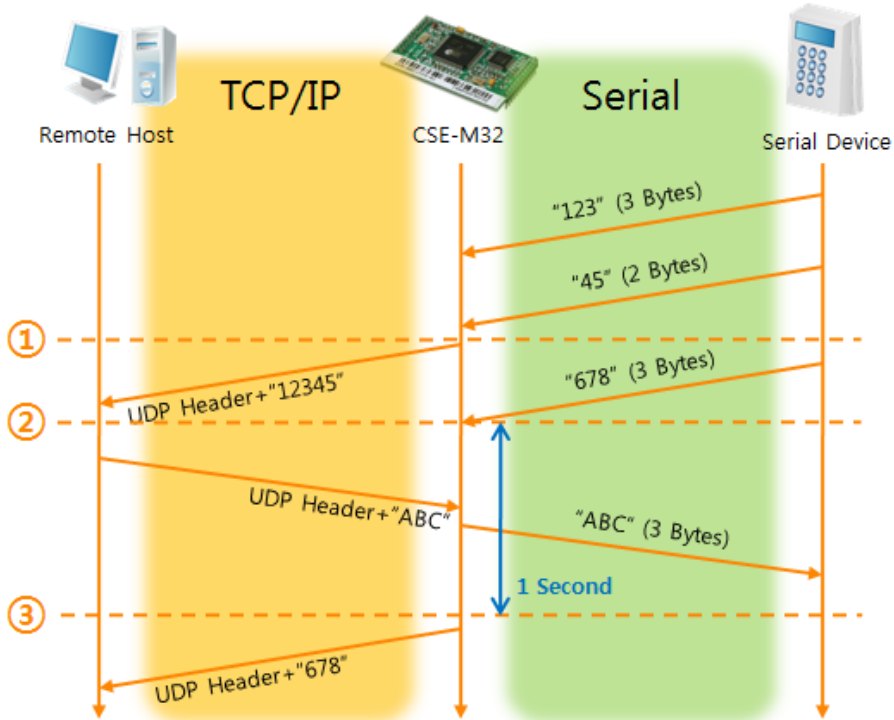

Figure 6-4 time chart for Block Size is 5 bytes and data frame is 1s

Table 6-5 states of each point

Points	States
~	CSE-M32 is receiving data from the serial port
①	CSE-M32 Sends 5 bytes as one block based on the [Block Size]
~	Serial device sends data "678" to the CSE-M32
②	Data "678" has arrived
~	CSE-M32 sends data from the remote host to the serial device
③	1 second has passed
~	CSE-M32 sends data "678" based on the [Data frame]

- Dynamic Update of Peer host

This is a function that CSE-M32 automatically sets its peer host with information of the last packet which is received from network. In the packet, the source address and port number is used.

Table 6-6 setting for [dynamic update of peer host] function

Parameters	Values
Peer Address	0 (None)
Peer Port	0

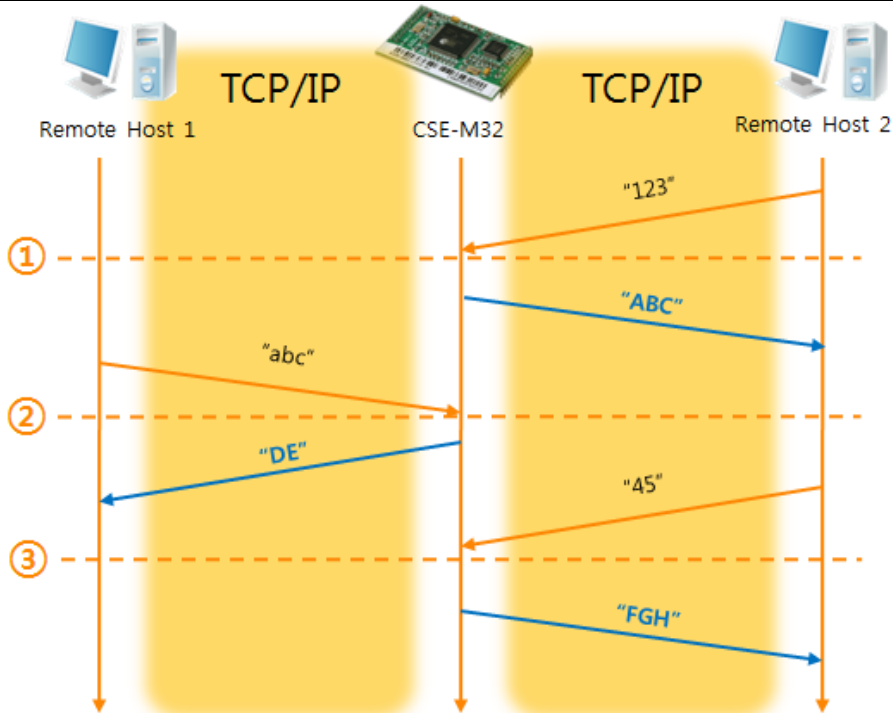

Figure 6-5 time chart for [dynamic update of peer host]

Table 6-7 states of each point

Points	States
~	Remote host 2 sends data to CSE-M32
①	CSE-M32 sets host 2 to peer host
~	Remote host 1 sends data to CSE-M32
②	CSE-M32 updates host 1 to peer host
~	Remote host 2 sends data again to CSE-M32
③	CSE-M32 updates host 2 to peer host
~	CSE-M32 can communicate with remote host 2

☞ **The data "ABC", "DE", "FGH" are from the serial port of CSE-M32 in the Fig 6-5.**

## 7 Security Protocols & Option

### 7.1 SSL

#### 7.1.1 SSL (Secure Socket Layer)

SSL is cryptographic protocol that provides secure communication on the Internet. The SSL works over TCP.

#### 7.1.2 How to set the SSL on CSE-M32

To works for SSL, you have to set the SSL-related parameters as the following steps.

- Set the [SSL] check box in the ezManager.

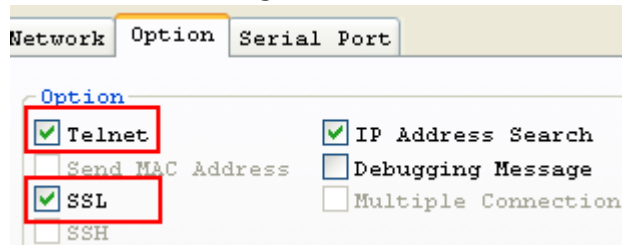

- Log in the CSE-M32 with telnet client.

☞ *For telnet login, please refer to the section 8.1.1*

- Generate an RSA key with a command. CSE-M32 supports 512, 768, and 1024 length keys.

Command Format: `rsa keygen [key length]`

```

CSE-M32 Management Console v1.3A Sollae Systems
lsh>rsa keygen 512
average 10sec required to find two 256bits prime numbers, please wait..
rsa: find 256bits random prime p..1 3 6 7 12 13 16 22 24 27 28 36 37 42 49 51 57
58 61 63 64 78 79 82 84 97 103 114 117 129 132 133 148 156 159 168 169 174 178
183 184 187 189 192 226 found
rsa: find 256bits random prime q..1 3 6 9 12 16 19 24 27 28 31 33 found
rsa: RSA key pair(public/private key) generated.
rsa: key validation OK
rsa: rsa_server_key exist, replaced to new key
lsh>
    
```

- Make a certificate with a 'cert new' command. The certificate is a self signed.

```

lsh>cert new
generating self-signed host certificate...555 done
-----BEGIN CERTIFICATE-----
MIICJzCCAdGgAwIBAgIBATANBgkqhkiG9w0BAQFADCBkIjELMAkGA1UEBhMCS1Ix
EDAOBgNVBAGlB0luY2h1b24xZjAMBgNVBAcTBU5hbUd1MRcwFQYDUQKQEW5Tb2xs
YVUgU3lzdGUtczERMAsGA1UECzMlUmUzZWZyY2gxZzARBgNVBAMTCjEwLjE2LjAu
MzIxIDAeBgkqhkiG9w0BCQWEEXN1cHBvcnRlZXB0Y3AuY29tMB4XDTEwMDEwMTAw
MDAwMFoXDTEwMTIzMTIzMTIzMTIzMTIzMTIzMTIzMTIzMTIzMTIzMTIzMTIzMTIz
bWNoZW9uMzAuMzAuMzAuMzAuMzAuMzAuMzAuMzAuMzAuMzAuMzAuMzAuMzAuMzAuMz
ETAjBgNVBAcTCEp1c2UhcnoMRMwEQYDUQKQEWoxMC4xNi41LjEwLjEwLjEwLjEwLj
hucNAQkBFhFzdXBlb3J0QGU6dGNwLmNoLmNoLmNoLmNoLmNoLmNoLmNoLmNoLmNoL
QQQoQe3no13wUP1Ekt/Nhb2DvDHnQ51ds/KSKIP7Xd34S2adi7W5G/dAptJDKs0g
jzYA7eFPLuPYfy1p0QzjuIPAgMBAAGjEDAOOMAwGA1UdEwQPMAMBaf8wDQYJKoZI
hvcNAQEEBQADQQA8F2Ae3nZZ9taudL9gHdtSKqedpYJF/EIWIxAgUUKvRfn1pWig
rcndz8IRnH61726uGONGQqpDiyUvIt+Ew2EZ
-----END CERTIFICATE-----
cert: host certificate exist, replaced to new one
lsh>
    
```

- Save the parameters for SSL with a 'ssl save aa55cc33' command.

```

C:\ Telnet 10.16.0.32
lsh>ssl save aa55cc33
save key...RSA CERT_host ok
lsh>_
    
```

### 7.1.3 Restriction

To use the SSL with CSE-M32, there is a restriction. You can use only one serial port (COM1) if you set the SSL function.

## 7.2 SSH

### 7.2.1 SSH (Secure Shell)

SSH is a network protocol that allows secure communications between two devices. You can use this function if your device is a serial port for console and you need secure communication.

### 7.2.2 How to set the SSH on CSE-M32

To works for SSL, you have to set the SSH-related parameters as the following steps.

- Set the [SSH] check box in the ezManager.

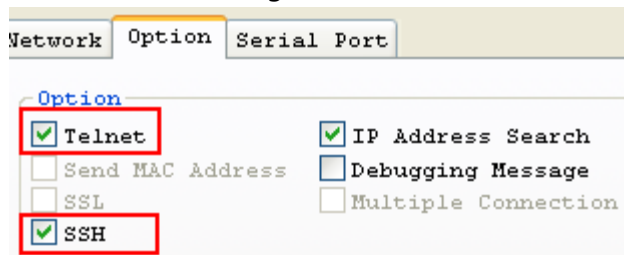

- Log in the CSE-M32 with telnet client.

☞ ***For telnet login, please refer to the section 8.1.1***

- Generate an RSA key with a command. CSE-M32 supports 512, 768, and 1024 length keys.

Command Format: `rsa keygen [key length]`

```

C:\ Telnet 10.16.0.32
CSE-M32 Management Console v1.3A Sollae Systems
lsh>rsa keygen 512
average 10sec required to find two 256bits prime numbers, please wait..
rsa: find 256bits random prime p..1 3 6 7 12 13 16 22 24 27 28 36 37 42 49 51 57
58 61 63 64 78 79 82 84 97 103 114 117 129 132 133 148 156 159 168 169 174 178
183 184 187 189 192 226 found
rsa: find 256bits random prime q..1 3 6 9 12 16 19 24 27 28 31 33 found
rsa: RSA key pair(public/private key) generated.
rsa: key validation OK
rsa: rsa_server_key exist, replaced to new key
lsh>
    
```

- Generate a DSA key with a 'dsa keygen'.

```

C:\ Telnet 10.16.0.32
lsh>dsa keygen 512
generating fips186 dsa key...done
verifying...done
lsh>
    
```

- Set a username and a password to log in with a 'ssh id' command for the SSH.

```

C:\ Telnet 10.16.0.32
lsh>ssh id
username: cse-m32
password: *****
retype: *****
ID update ok.
lsh>_
    
```

- Save the parameters for SSH with a 'ssh save aa55cc33' command.

```

C:\ Telnet 10.16.0.32
lsh>ssh save aa55cc33
save key...RSA DSA SSH_ID SSH_MSG ok
lsh>_
    
```

### 7.2.3 Restriction

To use the SSH function with CSE-M32, there is a restriction. You can use only T2S mode (TCP Server mode) if you set the SSH function

## 7.3 ezTCP Firewall

CSE-M32 has two connection limitation functions. Those can be set by the [Option] tab of the ezManager.

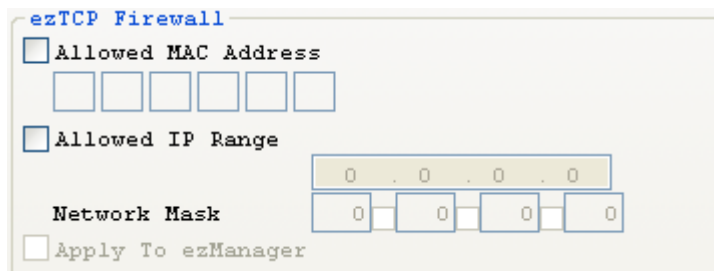

- Allowed MAC Address

If user sets the [Allowed MAC Address], the only specified host can be connected with the CSE-M32.

- Allowed IP Range

When the [Allowed IP] is set, the only hosts that are specified by [Allowed IP] and [Network Mask] can connect to the CSE-M32.

- examples

Allowed IP	Net Mask	Hosts who can connect to the CSE-M32
10.1.0.1	255.0.0.0	10.1.0.1 ~ 10.255.255.254
10.1.0.1	255.255.255.0	10.1.0.1 ~ 10.1.0.254
192.168.1.4	255.255.255.255	192.168.1.4

- Apply to ezManager

If this option is checked, hosts who are not specified above two restrictions can't search and configure CSE-M32 with ezManager. This is enabled when one of restrictions is set at least.

☞ ***All security functions are disabled in the ISP mode. So user can access the CSE-M32 in the ISP mode even though user can't access the CSE-M32 in the normal mode because of the [ezTCP Firewall] function.***

## 8 Checking & Debugging

If user logs in the CSE-M32, user can monitor CSE-M32 status. And if user sets the debugging option, user can get debugging data with ezManager.

### 8.1 Telnet

#### 8.1.1 Telnet Login

Once the [TELNET] option is activated, users can remotely log in to CSE-M32. If a password is set, users should input the password.

*Starting with firmware version 2.0A, you can login by entering "sollae" without setting a password.*

After then, messages from CSE-M32 appear like the below figure.

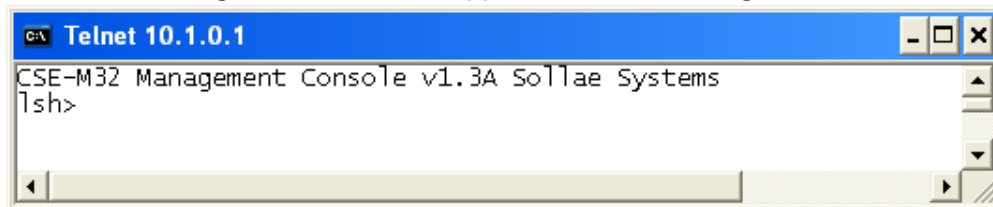

```

C:\ Telnet 10.1.0.1
CSE-M32 Management Console v1.3A Sollae Systems
lsh>
  
```

#### 8.1.2 Commands

- Network Status

User can monitor network status of CSE-M32 with the "st net" command.

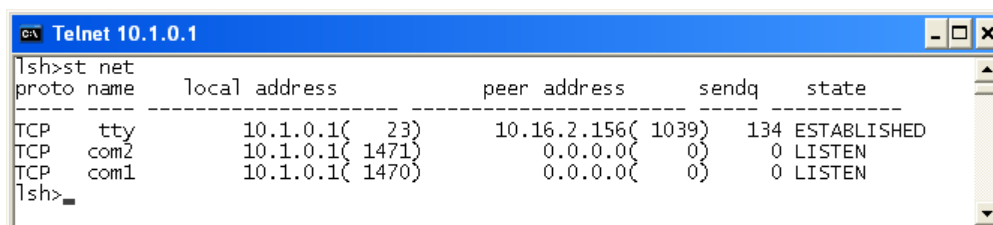

```

C:\ Telnet 10.1.0.1
lsh>st net
proto name      local address      peer address      sendq      state
-----
TCP    tty             10.1.0.1( 23)     10.16.2.156( 1039)  134 ESTABLISHED
TCP    com2            10.1.0.1( 1471)   0.0.0.0( 0)       0 LISTEN
TCP    com1            10.1.0.1( 1470)   0.0.0.0( 0)       0 LISTEN
lsh>
  
```

- Serial Ports' Status

User can monitor the statuses of two serial ports with the "st sio" command. The tx\_count and the rx\_count are the total data sizes to/from the serial ports.

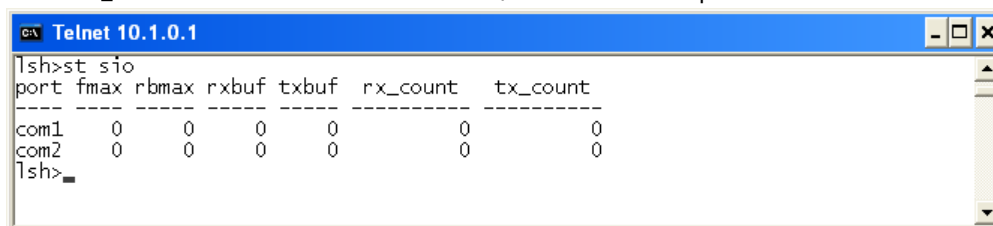

```

C:\ Telnet 10.1.0.1
lsh>st sio
port fmax rbmax rxbuf txbuf  rx_count  tx_count
-----
com1  0    0    0    0        0         0
com2  0    0    0    0        0         0
lsh>
  
```



- Checking Uptime

With "st uptime" command, you can check the time of your device boots up.

```

Telnet 10.1.0.1
lsh>st uptime
00:25:11.99 up 0 days
lsh>
    
```

- Serial Ports I/O data capture

This command is available on 1.2H or subsequently released firmware version. User can monitor the input / output data of CSE-M32's serial ports with the "sd" command. The way of using this command is like below.

"sd [SPACE] [# of Serial Port] [SPACE] [Interval]"

The value of [# of Serial Port] is that COM1 is "1" and COM2 is "2". [Interval] means duration of capturing and printing data on your screen and its unit is mille second (ms).

For example, if you want to capture the data in every second, the value of [Interval] should be 100.

```

Telnet 10.1.0.1
lsh>sd 1 100
com1 dump buffering time : 1000ms
lsh>sd 2 100
com2 dump start
com2 dump buffering time : 1000ms
lsh>tx1 => 61 62 63 64 65
rx1 <= 66 67 68
rx1 <= 69 6a
tx2 => 6b 6c 6d 6e 6f
rx2 <= 70 71
rx2 <= 72 73
rx2 <= 74
| abcde
| fgh
| ij
| klmno
| pq
| rs
| t
    
```

- Termination of TCP connection

Using "sc" command, users can terminate established TCP connection. The way of using this command is like below.

"sc [SPACE] [Name of Serial Port] [SPACE] close"

```

Telnet 10.1.0.1
lsh>sc com1 close
com1: closed
lsh>
    
```

## 8.2 Status on ezManager

### 8.2.1 Status of the CSE-M32

If the [Status] button is pressed on ezManager, user can monitor the current status of the CSE-M32 with ezManager. If user sets [Refresh Every 1 second] option, the status data will be updated in every second.

### 8.2.2 Closing TCP connection by the ezManager

User can terminate a TCP connection with the status window of the ezManager. If user clicks the right button of each TCP connection message of the TCP/IP Connection, user can terminate the TCP connection.

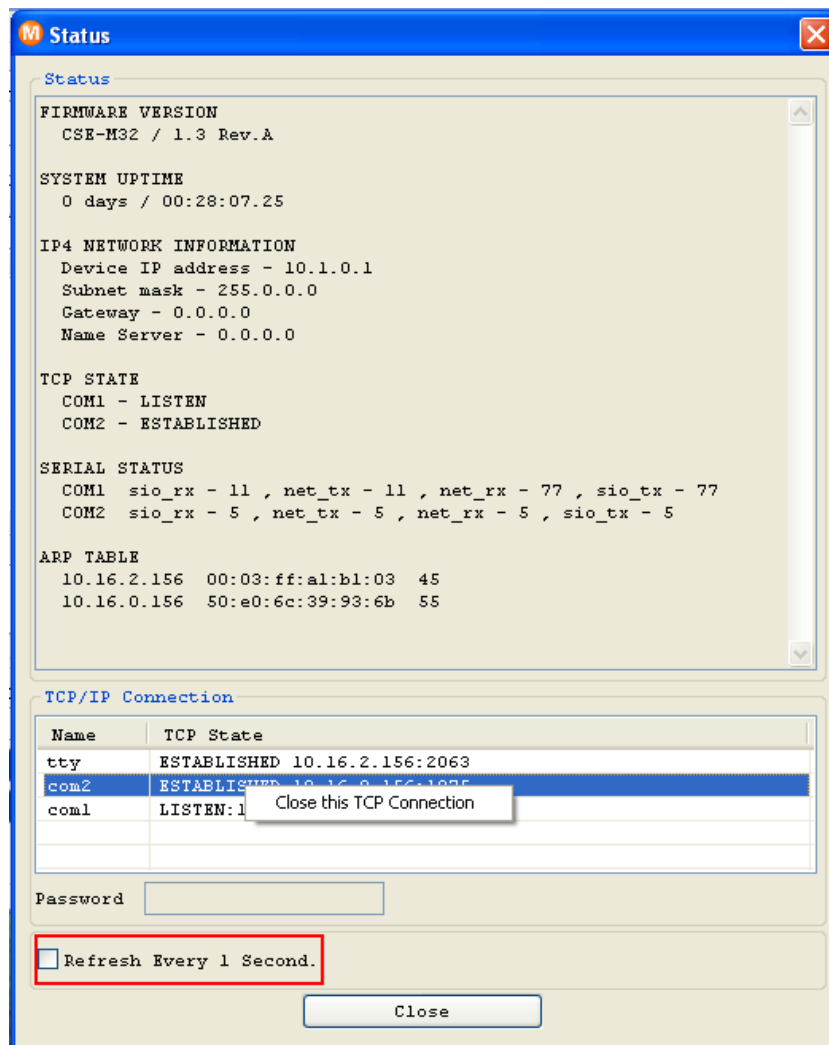

### 8.3 Remote Debugging

If the [Debugging Message] field in the [OPTION] tab of the ezManager, CSE-M32 transmits debugging messages with UDP port 50006. Then user can get the messages with new window if user presses [Debugging Message] button as followed:

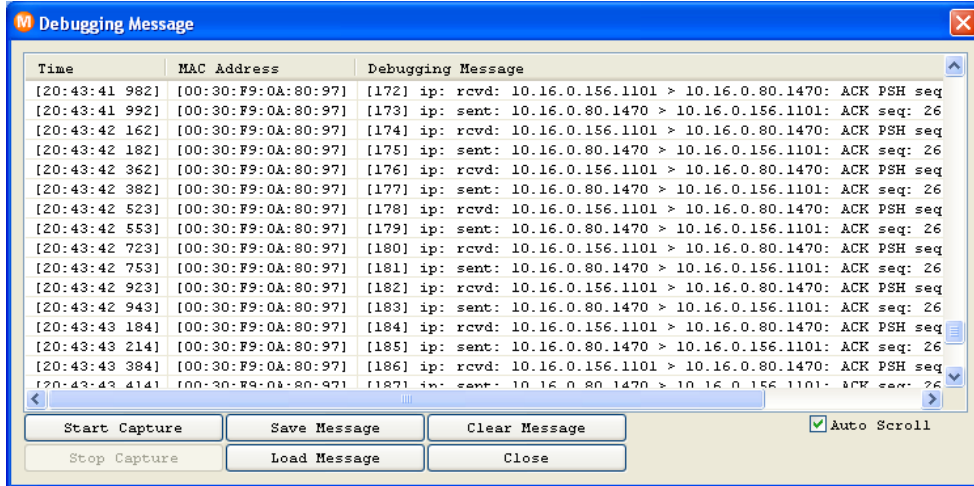

This function is very useful when there are any problems when users install the CSE-M32 in the user site.

## 9 The Evaluation Board

### 9.1 Introduction

This board is for testing the CSE-M32 with an Ethernet interface and 2 RS232 interfaces.

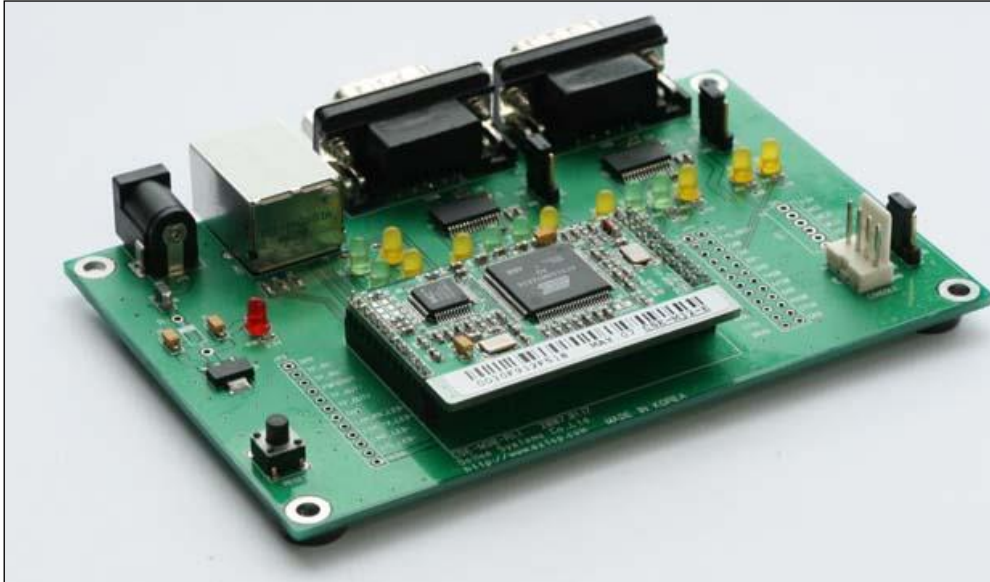

### 9.2 Connectors

Part	Name	Description
JP6	DC JACK	It supplies the power to the CSE-M32. The input voltage should be 5V. The regulator in the evaluation board regulate the 5V to 3.3V and supplies the 3.3V to the CSE-M32.
CON1	RJ45	10M/100M Ethernet
P1	DB9M	RS232 interface for COM1 (UART0)
P2	DB9M	RS232 interface for COM2 (UART1)
JP3	Header	Alternate port of JP1 of CSE-M32
JP4	Header	Alternate port of JP2 of CSE-M32
JP7	Connector	The console port of CSE-M32. It is for factory but not for customers.
JP8	Header	The SPI port. CSE-M32 doesn't use this port.

## 9.3 Jumpers and Switches

### 9.3.1 JP5

It is for ISP of CSE-M32.

Connection	The input signal to the ISP	Description
1-2 short	High	Normal Mode
2-3 short	Low	ISP Mode

When CSE-M32 boots up, it operates as Normal mode when the ISP is high. It operates as ISP mode when the ISP is low.

### 9.3.2 JP9, JP10

These pins control the outputs of the RS232 line drivers.

Connection	Input value of RS232 driver	Description
1-2 short	High	RS232 driver is active
2-3 short	Low	RS232 driver is inactive (high impedance)

These jumpers are very useful to connect user serial port and CSE-M32 with 3.3V level directly.

### 9.3.3 Reset Switch (S1)

It resets CSE-M32 by putting low signal to the RESET pin of CSE-M32.

## 9.4 System LEDs classified each mode

Mode	Name		Color	Status	Description
Common	PWR		Red	On	Supplying the power
Normal	LAN	STS	Yellow	Blinks in every second	Being assigned IP address
				Blinks 4 times in a second	Being not assigned IP address via DHCP or PPPoE
	LAN	LINK	Green	On	Connecting with Ethernet
		LAN_RX	Yellow	Blinks	Receiving data from Ethernet
		LAN_TX	Green	Blinks	Sending data to Ethernet
	SIO1 /SIO2	RXD0/1	Yellow	Blinks	Receiving data from Serial ports
		TXD0/1	Green	Blinks	Sending data from Serial ports
		RTS0/1	Green	On	Available to Receiving data (Using RTS/CTS Flow Control)
		CTS0/1	Yellow	On	Available to Sending data (Using RTS/CTS Flow Control)
	-	CN0/1	Yellow	On	Establishing TCP connection
ISP	-	All (except PWR)	-	Off	Entering ISP mode
Serial Configuration	LAN	LINK/ LAN_RX / LAN_TX/ STS	-	Blinks simultaneously	Entering Serial Configuration mode

## 9.5 Schematic of the evaluation board

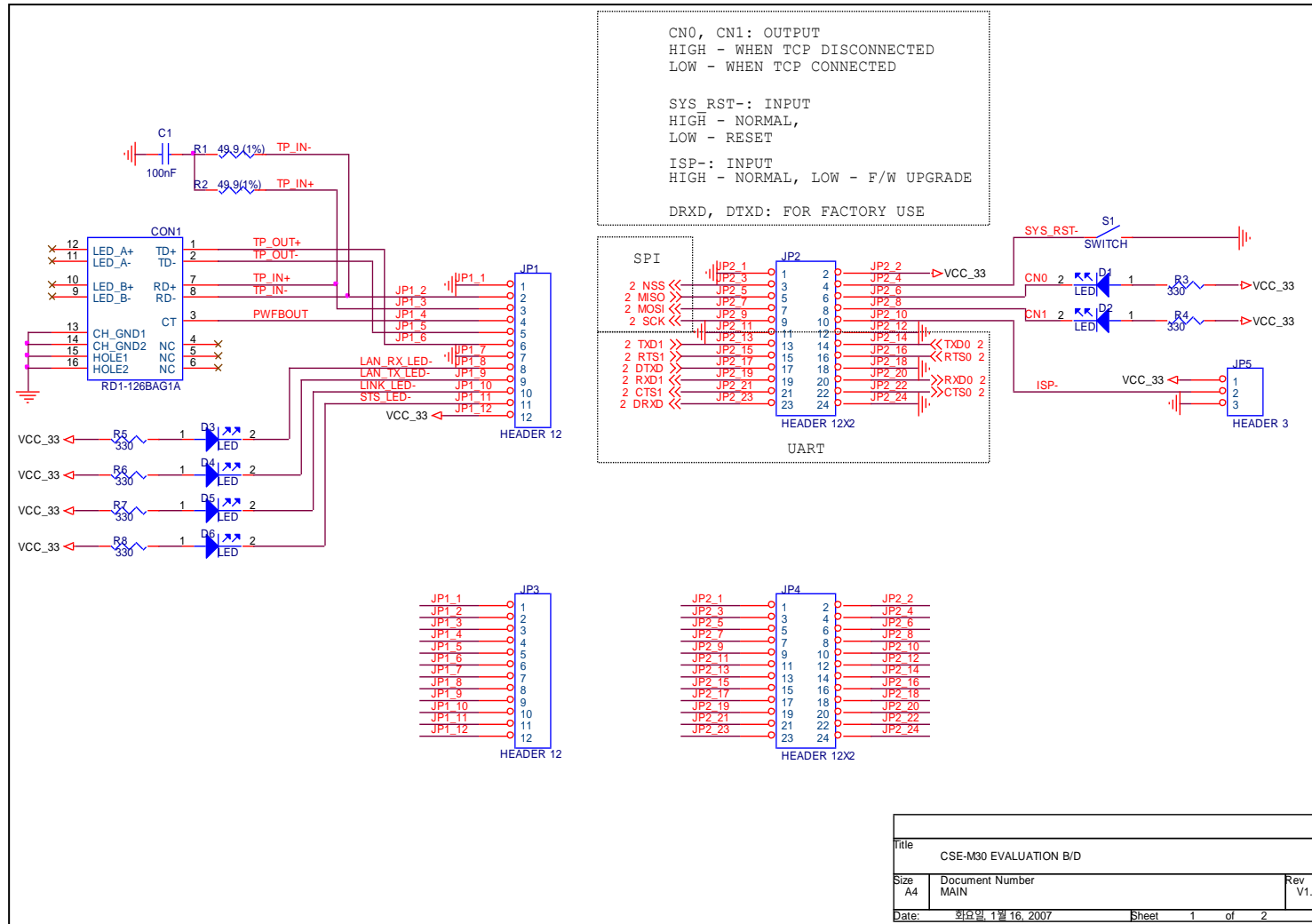

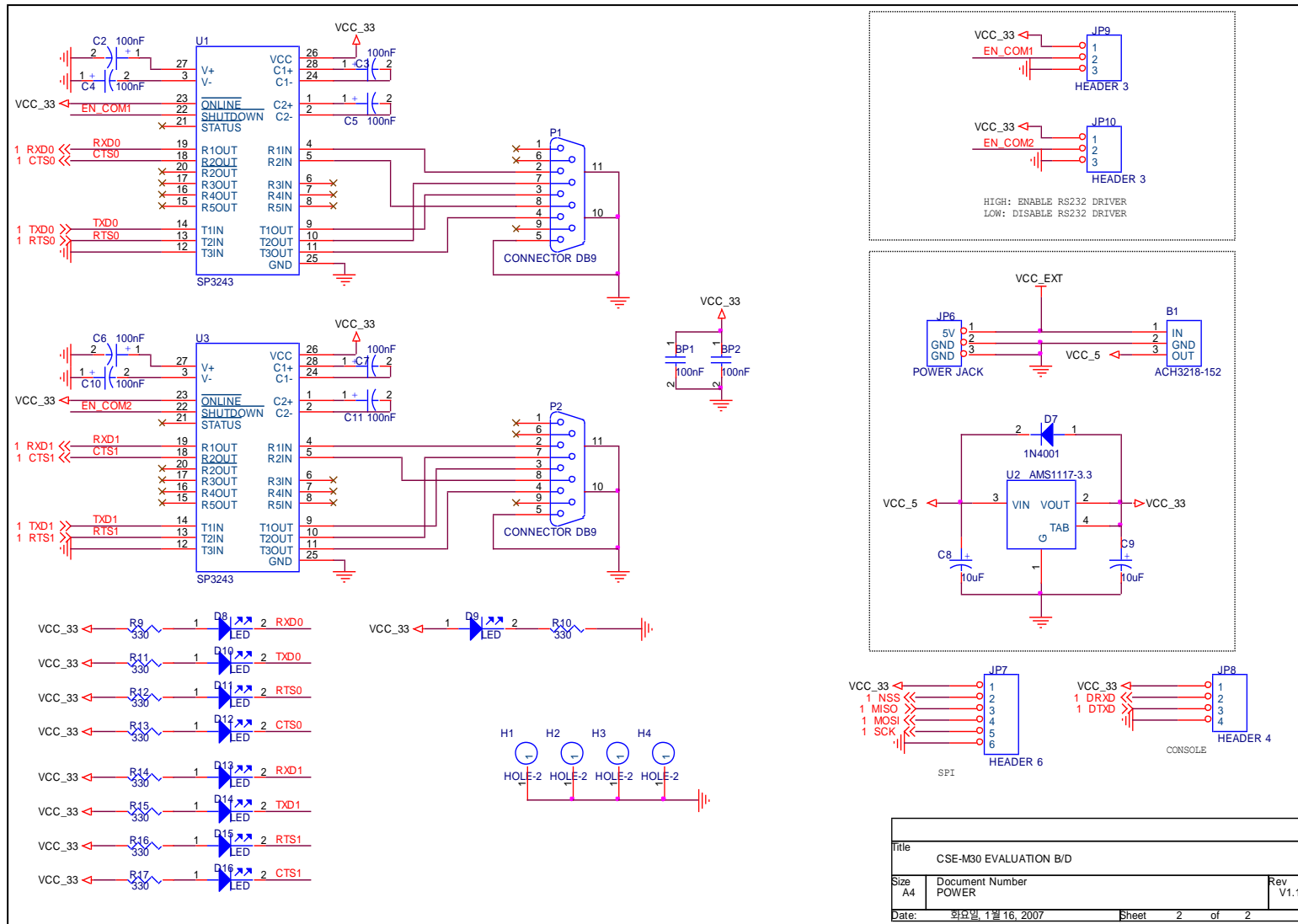

Title		
CSE-M30 EVALUATION B/D		
Size	Document Number	Rev
A4	POWER	V1.1
Date:	화요일, 1월 16, 2007	Sheet 2 of 2



## 10 Related material

### 10.1 Technical Documents

You can find the technical documents at our website.

- DataSheet
- IP Change Notification (DDNS)
- How to use SSL
- How to use SSH
- Sending MAC Address function
- Telnet COM Port Control Option
- etc

### 10.2 Smart phone application

- ezManager (iOS)
- ezManager (Android)
- TCP/IP Client (Android)

## 11 Technical Support and Warranty

### 11.1 Technical Support

If you have any question regarding operation of the product, visit Customer Support FAQ corner and the message board on Sollae Systems' web site or send us an email at the following address:

- E-mail: [support@eztcp.com](mailto:support@eztcp.com)
- Website Address for Customer Support: <https://www.eztcp.com/en/support/>

### 11.2 Warranty

#### 11.2.1 Refund

Upon the customer's request to refund the product within two weeks after purchase, Sollae Systems will refund the product.

#### 11.2.2 Free Repair Services

For product failures occurring within two years after purchase, Sollae Systems provides free repair services or exchange the product. However, if the product failure is due to user's fault, repair service fees will be charged or the product will be replaced at user's expense.

#### 11.2.3 Charged Repair Services

For product failures occurring after the warranty period (two years) or resulting from user's fault, repair service fees will be charged and the product will be replaced at user's expense.

## 12 Precaution and Exemption from Liability

### 12.1 Precaution

- Sollae Systems is not responsible for product failures occurring due to user's alteration of the product.
- Specifications of the product are subject to change without prior notice for performance improvement.
- Sollae Systems does not guarantee successful operation of the product if the product was used under conditions deviating from the product specifications.
- Reverse engineering of firmware and applications provided by Sollae Systems is prohibited.
- Use of firmware and applications provided by Sollae Systems for purposes other than those for which they were designed is prohibited.
- Do not use the product in an extremely cold or hot place or in a place where vibration is severe.
- Do not use the product in an environment in which humidity is high or a lot of oil exists.
- Do not use the product where there is caustic or combustible gas.
- Sollae Systems does not guarantee normal operation of the product under the conditions a lot of noise exists.
- Do not use the product for a purpose that requires exceptional quality and reliability relating to user's injuries or accidents – aerospace, aviation, health care, nuclear power, transportation, and safety purposes.
- Sollae Systems is not responsible for any accident or damage occurring while using the product.

## 12.2 Exemption from Liability

### 12.2.1 English version

In no event shall Sollae Systems Co., Ltd. And its distributors be liable for any damages whatsoever (including, without limitation, damages for loss of profit, operating cost for commercial interruption, loss of information, or any other financial loss) from the use or inability to use the CSE-M32 even if Sollae Systems Co., Ltd. Or its distributors have been informed of such damages.

The CSE-M32 is not designed and not authorized for use in military applications, in nuclear applications, in airport applications or for use in applications involving explosives, or in medical applications, or for use in security alarm, or for use in a fire alarm, or in applications involving elevators, or in embedded applications in vehicles such as but not limited to cars, planes, trucks, boats, aircraft, helicopters, etc..

In the same way, the CSE-M32 is not designed, or intended, or authorized to test, develop, or be built into applications where failure could create a dangerous situation that may result in financial losses, damage to property, personal injury, or the death of people or animals. If you use the CSE-M32 voluntarily or involuntarily for such unauthorized applications, you agree to subtract Sollae Systems Co., Ltd. And its distributors from all liability for any claim for compensation.

Sollae Systems Co., Ltd. And its distributors entire liability and your exclusive remedy shall be Sollae Systems Co., Ltd. And its distributors option for the return of the price paid for, or repair, or replacement of the CSE-M32.

Sollae Systems Co., Ltd. And its distributors disclaim all other warranties, either expressed or implied, including, but not limited to, the implied warranties of merchantability and fitness for a particular purpose, with respect to the CSE-M32 including accompanying written material, hardware and firmware.

### 12.2.2 French version

- Documentation

La documentation du boîtier CSE-M32 est conçue avec la plus grande attention. Tous les efforts ont été mis en œuvre pour éviter les anomalies. Toutefois, nous ne pouvons garantir que cette documentation soit à 100% exempt de toute erreur. Les informations présentes dans cette documentation sont données à titre indicatif. Les caractéristiques techniques peuvent changer à tout moment sans aucun préavis dans le but d'améliorer la qualité et les possibilités des produits.



- Copyright et appellations commerciales

Toutes les marques, les procédés, les références et les appellations commerciales des produits cités dans la documentation appartiennent à leur propriétaire et Fabricant respectif.

- Conditions d'utilisations et limite de responsabilité

En aucun cas Sollae Systems Co., Ltd. ou un de ses distributeurs ne pourra être tenu responsable de dommages quels qu'ils soient (intégrant, mais sans limitation, les dommages pour perte de bénéfice commercial, interruption d'exploitation commerciale, perte d'informations et de données à caractère commercial ou de toute autre perte financière) provenant de l'utilisation ou de l'incapacité à pouvoir utiliser le boîtier CSE-M32, même si Sollae Systems Co., Ltd. ou un de ses distributeurs a été informé de la possibilité de tels dommages.

Le boîtier CSE-M32 est exclusivement prévu pour un usage en intérieur, dans un environnement sec, tempéré (+10 °C à +40°C) et non poussiéreux. Le boîtier CSE-M32 n'est pas prévu, ni autorisé pour être utilisé en extérieur, ni de façon embarquée dans des engins mobiles de quelque nature que ce soit (voiture, camion, train, avion, etc...), ni en milieu explosif, ni dans des enceintes nucléaires, ni dans des ascenseurs, ni dans des aéroports, ni dans des enceintes hospitaliers, ni pour des applications à caractère médical, ni dans des dispositifs de détection et d'alerte anti-intrusion, ni dans des dispositifs de détection et d'alerte anti-incendie, ni dans des dispositifs d'alarme GTC, ni pour des applications militaires.

De même, le boîtier CSE-M32 n'est pas conçu, ni destiné, ni autorisé pour expérimenter, développer ou être intégré au sein d'applications dans lesquelles une défaillance de celui-ci pourrait créer une situation dangereuse pouvant entraîner des pertes financières, des dégâts matériel, des blessures corporelles ou la mort de personnes ou d'animaux. Si vous utilisez le boîtier CSE-M32 volontairement ou involontairement pour de telles applications non autorisées, vous vous engagez à soustraire Sollae Systems Co., Ltd. et ses distributeurs de toute responsabilité et de toute demande de dédommagement.

En cas de litige, l'entière responsabilité de Sollae Systems Co., Ltd. et de ses distributeurs vis-à-vis de votre recours durant la période de garantie se limitera exclusivement selon le choix de Sollae Systems Co., Ltd. et de ses distributeurs au remboursement de votre produit ou de sa réparation ou de son échange. Sollae Systems Co., Ltd. et ses distributeurs démentent toutes autres garanties, exprimées ou implicites.



Tous les boîtiers CSE-M32 sont testés avant expédition. Toute utilisation en dehors des spécifications et limites indiquées dans cette documentation ainsi que les court-circuit, les chocs, les utilisations non autorisées, pourront affecter la fiabilité, créer des dysfonctionnements et/ou la destruction du boîtier CSE-M32 sans que la responsabilité de Sollae Systems Co., Ltd. et de ses distributeurs ne puissent être mise en cause, ni que le boîtier CSE-M32 puisse être échangé au titre de la garantie.

- Rappel sur l'évacuation des équipements électroniques usagés

Le symbole de la poubelle barré présent sur le boîtier CSE-M32 indique que vous ne pouvez pas vous débarrasser de ce dernier de la même façon que vos déchets courants. Au contraire, vous êtes responsable de l'évacuation du boîtier CSE-M32 lorsqu'il arrive en fin de vie (ou qu'il est hors d'usage) et à cet effet, vous êtes tenu de le remettre à un point de collecte agréé pour le recyclage des équipements électriques et électroniques usagés. Le tri, l'évacuation et le recyclage séparés de vos équipements usagés permettent de préserver les ressources naturelles et de s'assurer que ces équipements sont recyclés dans le respect de la santé humaine et de l'environnement. Pour plus d'informations sur les lieux de collecte des équipements électroniques usagés, contacter votre mairie ou votre service local de traitement des déchets.

## 13 Revision History

Date	Version	Comment	Author
Jan.15.2007	0.5	○ Initial touch	
May.25.2007	1.0	○ Initial release	
Aug.31.2007	1.1	○ Add Serial Interface ○ Add Ethernet Interface ○ Add Telnet COM Port Control Option	
Sep.27.2007	1.2	○ Add DDNS(Dynamic DNS) Function	
Dec.4.2008	1.3	○ Add SSL, SSH function ○ Modify ISP- pin function ○ Modify RTS/CTS Flow-control ○ Modify Test Method ○ Add AT+PNIP, AT+PRHN ○ Add Connect with a host name in ATC Mode ○ Add Close TCP function	
Dec.11.2008	1.4	○ Add recommended RJ45 connectors	
Jan.08.2009	1.5	○ Add Security Function in the ISP mode	
Feb.26.2009	1.6	○ Add DC Electric Characteristics	
Mar.04.2009	1.7	○ Add description of serial I/O data capture by using telnet. (sd command) ○ Add description of U2S echo ○ Correct Some Expressions	
Mar.31.2009	1.8	○ Add 10.4 System LEDs ○ Modify the table of 7.7.1 ○ Modify 11.1 Technical Support ○ Correct Some Expressions	
Apr.18.2009	1.9	○ Correct overlapped schematics	
Jul.13.2009	2.0	○ Add description of Send MAC Address function ○ Add description of AT+PSE command ○ Add description of changing local port in ATC mode ○ Add description of Termination of TCP connection in 9.1.2 ○ Add description of sc command in TELNET ○ Update most of pictures including ezManager and Telnet ○ Modify the table of 10.4 System LEDs	

		<ul style="list-style-type: none"> <li>○ Modify the 4.2 Configuration with ezManager</li> <li>○ Modify the description about F/W upgrade</li> <li>○ Modify the 4.6 Notify IP change</li> <li>○ Change the form of document</li> <li>○ Correct some expressions</li> </ul>	
Dec.02.2009	2.1	<ul style="list-style-type: none"> <li>○ The table of "JP2" has been modified.</li> <li>○ Form of Revision History has been modified.</li> <li>○ Operating/Storage temperature has been added.</li> </ul>	Roy LEE
Aug.03.2011	2.2	<ul style="list-style-type: none"> <li>○ Add description of serial options. (FIFO, Data frame interval... etc)</li> <li>○ Update a screenshot of ezManager.</li> </ul>	Amy KIM
Jan.11.2012	2.3	<ul style="list-style-type: none"> <li>○ Caution about service using of DynDNS has been added</li> <li>○ Descriptions of FIFO function has been deleted.</li> </ul>	Peter LEE
June.21.2012.	2.4	<ul style="list-style-type: none"> <li>○ Extend the warranty period to two years</li> <li>○ Remove description about PPPoE and DHCP</li> </ul>	Peter LEE
Feb.14.2013	2.5	<ul style="list-style-type: none"> <li>○ Add description of reset time</li> </ul>	Peter LEE
May.14.2013	2.6	<ul style="list-style-type: none"> <li>○ Add related material</li> <li>○ Add exemption from liability</li> </ul>	Peter LEE
Oct.28.2013	2.7	<ul style="list-style-type: none"> <li>○ Modify current consumption</li> </ul>	Peter LEE
Jan.02.2014	2.8	<ul style="list-style-type: none"> <li>○ Correct some expressions</li> <li>○ Modify the description about ATC mode</li> <li>○ Modify the description about UDP</li> </ul>	Peter LEE
Mar.22.2016	3.0	<ul style="list-style-type: none"> <li>○ Add explanation for telnet login.</li> </ul>	Peter LEE
Apr.25.2018	3.1	<ul style="list-style-type: none"> <li>○ Change explanation for 3.3V TTL</li> </ul>	Sara Lee
May.30.2018.	3.2	<ul style="list-style-type: none"> <li>○ Update the application circuit</li> </ul>	Roy LEE