HC12 Welcome Kit

Hardware Version 1.0

Monitor Version 1.2

User Manual

English Release

October 7 1999

Copyright (C)1996-98 by
MCT Elektronikladen GbR
Hohe Str. 9-13 D-04107 Leipzig
Telefon: +49-(0)341-2118354
Fax: +49-(0)341-2118355
mailto:leipzig@elektronikladen.de
<http://www.elektronikladen.de/mct>

This manual and the product described herein were designed carefully by the manufacturer. We made every effort to avoid mistakes but we do not guarantee that it is 100% free of errors.

The manufacturers entire liability and your exclusive remedy shall be, at the manufacturers option, return of the price paid or repair or replacement of the product. The manufacturer disclaims all other warranties, either expressed or implied, including but not limited to implied warranties of merchantability and fitness for a particular purpose, with respect to the product including accompanying written material, hardware and firmware.

In no event shall the manufacturer or its supplier be liable for any damages whatsoever (including, without limitation, damages for loss of business profits, business interruption, loss of business information, or other pecuniary loss) arising out of the use of or inability to use the product, even if the manufacturer has been advised of the possibility of such damages. The product is not designed, intended or authorized for use in applications in which the failure of the product could create a situation where personal injury or death may occur. Should you use the product for any such unintended or unauthorized application, you shall indemnify and hold the manufacturer and its suppliers harmless against all claims, even if such claim alleges that the manufacturer was negligent regarding the design or implementation of the product.

Product features and prices may change without notice.

All trademarks are properties of their respective holders.

Contents

Technical Support	2
Schematic	3
Parts Location Diagram	6
Connectors	8
Jumpers	10
Memory Map	11
Technical Data	12
TwinPEEKs Monitor	13

Technical Support

To receive technical support please contact your local Elektronikladen dealer.

You may also send email to the Elektronikladen support team via the following email address:

support@elektronikladen.de

Schematic

The main component on the HC12 Welcome Kit board is an 68HC812A4 microcontroller (U1) from Motorola. The MCU is accompanied by a reset chip (low voltage inhibitor, U2) to avoid problems whenever the voltage is below operating level. This device generates a reset if the voltage is below 2.8V. The threshold level is set so low in order to operate the kit both with 5 and 3 volts. Please note: We recommend to operate the HC12 with 5V, since Motorola deleted the 3V specification in newer issues of the HC812A4 Technical Data documents. The RS232 level converter (U3) was selected accordingly, it works at both voltages too.

The MCU generates its clocks from a 16 MHz crystal connected to the XTAL and EXTAL pins. The HC12 also has a PLL which is not used here. If you would like to use the PLL feature, you must replace the crystal and add the components C4, C5 and R6. Motorola has an application note about how to choose the appropriate values.

All controller signals (except XTAL and XFC) are available via two double row header connectors (ST5, ST6). The connectors are not mounted as factory default to allow you to solder them up- or downward, depending on your application.

The jumpers JP1, JP2 and JP3 select the operating mode of the MCU. See section "Jumpers" for details. JP4 is not really a jumper but a connector for an external reset switch.

BR1 and BR2 are solder pads on the solder side of the PCB. They are closed by default. You may open them if you want to supply VDDA and/or VRH voltages different from VCC to the ADC subsystem.

ST1 is a Motorola compliant 6 pin header for the BDM interface of the HC12. You may use it to connect a BDM pod while debugging a program.

There is another 6 pin header (ST2) which is an optional BDM output. Presently ST2 has no

specific function on the HC12 Welcome Kit apart from the fact that it carries two general purpose I/O port pins of the MCU.

The I/O pins of the HC812A4 have internal pull-up resistors, so there shouldn't be problems leaving these pins unterminated.

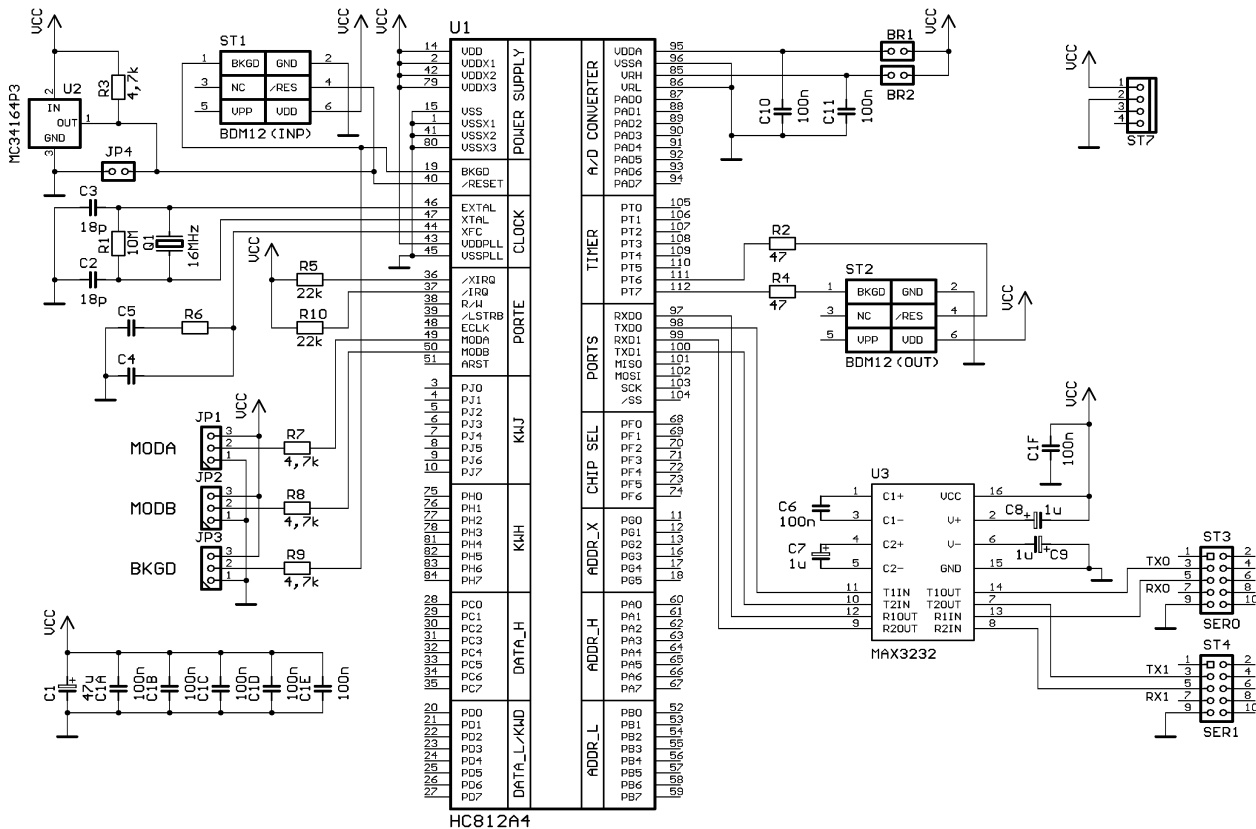

Alle Prozessorsignale (außer XTAL und XFC) sind auf ST5 bzw. ST6 (je 2x25pol. Stiftleiste) herausgeführt

HC12 Welcome Kit

Version: 1.0

07.12.1996 21:11:44

Copyright by MCT Lange & Thamm Mikrocomputertechnik GbR

Parts Location Diagram

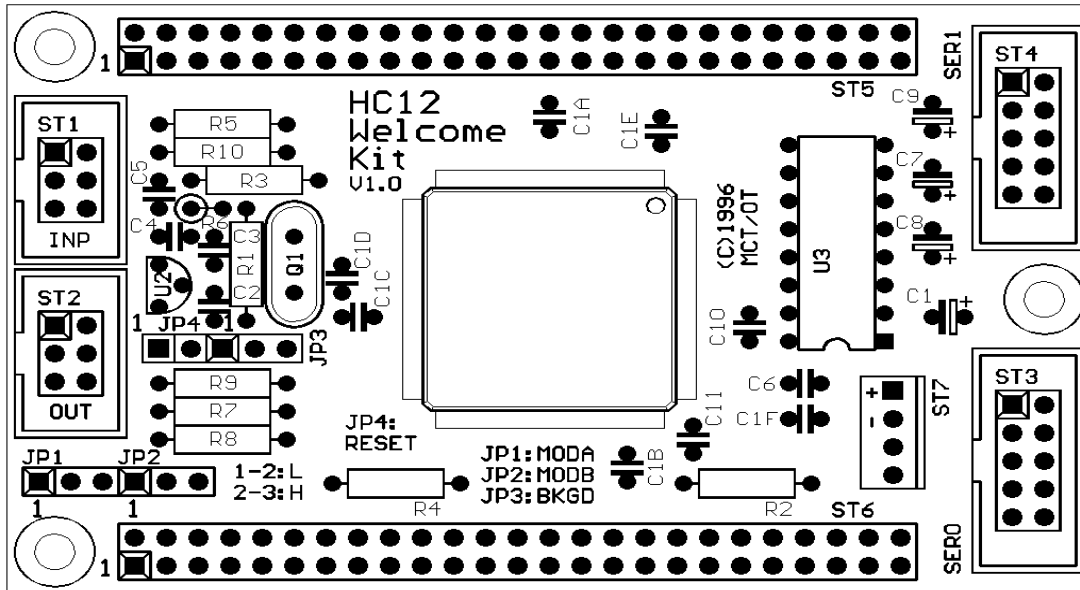

Part No.	Value	Description	Comment
R1	10M	Resistor	axial
R2,R4	47	Resistor	axial
R3,R7,R8,R9	4,7k	Resistor	axial
R5,R10	22k	Resistor	axial
C1	47 μ F / 10V	Electrolytic Capacitor	0.1"
C2,C3	18pF	Ceramic Capacitor	0.1"
C6, C10, C11, C1A, C1B, C1C, C1D, C1E, C1F	100nF	Ceramic Capacitor	0.1"
C7,C8,C9	1 μ F / 25V	Electrolytic Capacitor	0.1"
Q1	16MHz	Crystal	HC49U/4
U1	68HC812A4	MCU	TQFP112
U2	MC34164P3	Reset Chip	TO92
U3	MAX3232CPE	RS232 Transceiver	DIP16
JP1,JP2,JP3	Header1x3	Jumper	
JP4	Header1x2	Jumper	
ST1,ST2	Header2x3	Header 6p.	
ST3,ST4	Header2x5	Header 10p.	
ST5,ST6	PF2x25	Header 50p.	
ST7	SV_F35M	Power Supply Connector	
BR1,BR2		Solder pads (on solder side of PCB)	
C4,C5,R6		Optional parts for the PLL (not used here)	

Connectors

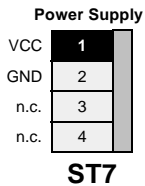
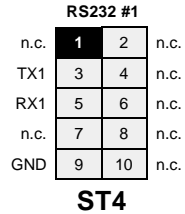
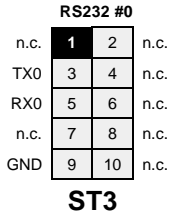
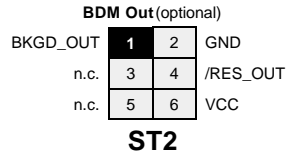
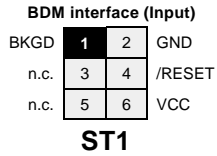

























ECLK/PE4	1	2	EXTAL
MODB/PE6	3	4	MODA/PE5
PB0	5	6	ARST/PE7
PB2	7	8	PB1
PB4	9	10	PB3
PB6	11	12	PB5
PA0	13	14	PB7
PA2	15	16	PA1
PA4	17	18	PA3
PA6	19	20	PA5
PF0	21	22	PA7
PF2	23	24	PF1
PF4	25	26	PF3
PF6	27	28	PF5
PH1	29	30	PH0
PH3	31	32	PH2
PH5	33	34	PH4
PH7	35	36	PH6
PAD0	37	38	VRH
PAD2	39	40	PAD1
PAD4	41	42	PAD3
PAD6	43	44	PAD5
VDDA	45	46	PAD7
TXD0	47	48	RXD0
GND	49	50	VCC

ST6

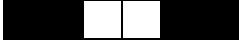
/RESET	1	2	LSTRB/PE3
RW/PE2	3	4	IRQ/PE1
XIRQ/PE0	5	6	PC7
PC6	7	8	PC5
PC4	9	10	PC3
PC2	11	12	PC1
PC0	13	14	PD7
PD6	15	16	PD5
PD4	17	18	PD3
PD2	19	20	PD1
PD0	21	22	BKGD
PG5	23	24	PG4
PG3	25	26	PG2
PG1	27	28	PG0
PJ7	29	30	PJ6
PJ5	31	32	PJ4
PJ3	33	34	PJ2
PJ1	35	36	PJ0
PT7/BKGD_OUT	37	38	PT6/RES_OUT
PT5	39	40	PT4
PT3	41	42	PT2
PT1	43	44	PT0
PS7	45	46	PS6
PS5	47	48	PS4
TXD1	49	50	RXD1

ST5

Jumpers

MODA			MODB			BKGD			Operating Mode
JP1			JP2			JP3			
1	2	3	1	2	3	1	2	3	
									Special Single Chip
									Special Expanded Narrow
									Special Peripheral
									Special Expanded Wide
									Normal Single Chip (Factory Default)
									Normal Expanded Narrow
									Reserved (Forced to Peripheral)
									Normal Expanded Wide

Memory Map

Single Chip Mode:

Memory Area	Resource
\$0000 - \$01FF	Registers (relocatable in 2KB steps)
\$0800 - \$0BFF	RAM (relocatable in 2KB steps)
\$F000 - \$FFFF	EEPROM

Expanded Mode:

Memory Area	Resource
\$0000 - \$01FF	Register (relocatable in 2KB steps)
\$0800 - \$0BFF	RAM (relocatable in 2KB steps)
\$1000 - \$1FFF	EEPROM (relocatable in 4KB steps)

Technical Data

MCU 68HC812A4

- 16 MHz crystal clock (8 MHz internal clock)
- 1024 bytes RAM
- 4096 bytes EEPROM
- 8 channel 16 bit Timer
- 16 Bit Pulse Accumulator
- Watchdog and Clock Monitor
- 2 x SCI, 1 x SPI
- 8 channel 8 bit A/D Converter
- up to 24 Key Wakeup Ports
- 112 pin TQFP package

Dimensions

- 86 mm x 54 mm / 3.4" x 2.1"

Power Supply

- 4.5 ... 5.5 V operating voltage
- Typical current consumption: 25mA

TwinPEEKs Monitor

Software Version 1.2

Overview

Every HC12 Welcome Kit contains the TwinPEEKs software monitor. TwinPEEKs starts automatically if you set the operating mode of the MCU to Normal Single Chip Mode.

TwinPEEKs occupies the upper half of the internal EEPROM space (2KB out of 4KB) and 256 Bytes RAM (so the first 768 Bytes are free). The monitor protects itself from being deleted after every reset. You will need a separate BDM-Downloader to replace the monitor software.

To communicate with a Host-PC use the first RS232 channel (SCI0) of the HC12 Welcome Kit and set your PC terminal program to 9600 Baud, 8N1, no handshake.

All memory writes to the user EEPROM area (the lower 2 KB) will be handled by the monitor automatically.

Monitor Commands

Monitor commands start with a single character (for the specific command) and one or more hexadecimal parameters separated by a whitespace or comma. The address range of the MCU is 64KB, so addresses are up to 4 (hex) digits long. Ending addresses are in the form "Last address +1". The Example displays the memory contents from \$F100 to \$F1FF:

```
D F100 F200
```

D: Dump Memory

- Syntax: D [<AADR> [<EADR>]]
- Examples:

d f000 f800	Display memory from \$F000 to \$F7FF.
d f000	Display memory from \$F000. Stop \$0100 Bytes after starting address.
d	Display the next \$0100 Bytes.

E: Edit Memory

- Syntax: E [<AADR>]
- Examples:

e f000	Edit memory from \$F000
e	Edit memory (use last ending address)

In Edit Mode you can change a byte or use one of the following commands:

<ENTER>	Go to next memory location.
-	Go to previous memory location.
=	Re-read the current memory location.
.	Quit Edit Mode
0	Quit Edit Mode

F: Fill Memory

- Syntax: F <AADR> <EADR> <BY>
- Examples:

f f000 f800 ff	Fill the memory area from \$F000 to \$F7FF with the value \$FF
----------------	--

G: Goto Address

- Syntax: G [<AADR>]
- Examples:

g f100	Call user program at \$F100
g	Call user program at current address

H: Help

- Syntax: H
- Examples:

h	Display help message
---	----------------------

L: Load S-Records

- Syntax: L [<OFFS>]
- Examples:

l	Load S-Record file into memory
l e000	Load S-Record file into memory and relocate all addresses in the S-Record file by the offset \$E000

Usage: First type in the load command. The monitor displays the message "Loading...". Now you can send the S-Record file using the ASCII upload function of your terminal program.

The monitor does not echo the characters received. The function aborts if a write error occurs. The user may interrupt the function by pressing <ESC>.

The monitor can process S0, S1 and S9 type records.

Please take care when writing to EEPROM locations: Every write access can take up to 20ms (10ms erase time + 10ms write time). TwinPEEKs handles EEPROM write accesses, but the user must not send the data faster than it can be written.

The easiest way to ensure the correct download timing is to use a line-by-line transmission. For

this purpose, the monitor sends an acknowledge character "*" after each S-Record line, that was processed. Setup your PC terminal program in a way that it waits for this handshake character. This option is available in most terminal programs - even the TERMINAL.EXE application from Windows 3.1. has such an option.

Another way to avoid timing problems is to load your code with full speed into RAM and then move it into EEPROM. Here comes an example: Your code occupies \$F000..\$F200. First load it into the RAM area \$0800..\$0A00 using the load command with an offset of \$1800: "L 1800". Then you can move your program to the final (EEPROM) destination with: "M 0800 0A00 F000".

M: Move Memory

Syntax: M <AADR> <EADR> <ADR2>

Examples:

m 1000 1800 f000	Copy the contents of memory from \$1000...\$17FF to \$F000 (...\$F7FF)
------------------	--

Autostart function

If you want that your user program (beginning at \$F000) starts automatically after reset, then just connect the pins 35 (PH7) and 37 (PAD0) of connector ST6! The monitor detects this connection after reset and jumps directly to address \$F000.

Pseudo Interrupt Vectors

TwinPEEKs occupies the memory area which contains the interrupt vectors. To give the user program access to interrupt vectors, TwinPEEKs remaps all the "ROM"-vectors to RAM locations. This is equal to the pseudo vectors of the HC11 in Special Bootstrap Mode.

To use an interrupt vector in the user program you simply place a JMP instruction in the corresponding RAM interrupt vector. Here is an example for the SPI:

```
l daa #$06           ; JMP Opcode
staa $0BC7          ; SPI Pseudo Vector
l dd #i srFunc      ; Jump Address
std $0BC8           ; SPI Pseudo Vector + 1
```

The following listing is part of the TwinPEEKs monitor program. It shows, which interrupt vector is placed as a pseudo vector at which address in RAM:

```
FFCE : 0B B8   dc. w  RAMTOP-72   ; KWH
FFD0 : 0B BB   dc. w  RAMTOP-69   ; KWJ
FFD2 : 0B BE   dc. w  RAMTOP-66   ; ATD
FFD4 : 0B C1   dc. w  RAMTOP-63   ; SCI 1
FFD6 : 0B C4   dc. w  RAMTOP-60   ; SCI / SCI 0
```

```

FFD8 : 0B C7    dc. w  RAMTOP-57    ; SPI
FFDA : 0B CA    dc. w  RAMTOP-54    ; Pul se Accu Input Edge
FFDC : 0B CD    dc. w  RAMTOP-51    ; Pul se Accu Overfl ow
FFDE : 0B D0    dc. w  RAMTOP-48    ; Ti mer Overfl ow
FFE0 : 0B D3    dc. w  RAMTOP-45    ; TOC5 / TC7
FFE2 : 0B D6    dc. w  RAMTOP-42    ; TOC4 / TC6
FFE4 : 0B D9    dc. w  RAMTOP-39    ; TOC3 / TC5
FFE6 : 0B DC    dc. w  RAMTOP-36    ; TOC2 / TC4
FFE8 : 0B DF    dc. w  RAMTOP-33    ; TOC1 / TC3
FFEA : 0B E2    dc. w  RAMTOP-30    ; TI C3 / TC2
FFEC : 0B E5    dc. w  RAMTOP-27    ; TI C2 / TC1
FFEE : 0B E8    dc. w  RAMTOP-24    ; TI C1 / TC0
FFF0 : 0B EB    dc. w  RAMTOP-21    ; RTI
FFF2 : 0B EE    dc. w  RAMTOP-18    ; I RQ / KWUD
FFF4 : 0B F1    dc. w  RAMTOP-15    ; XI RQ
FFF6 : 0B F4    dc. w  RAMTOP-12    ; SWI
FFF8 : 0B F7    dc. w  RAMTOP-9     ; I l l e g a l   O p c o d e
FFFA : 0B FA    dc. w  RAMTOP-6     ; C O P   F a i l
FFFC : 0B FD    dc. w  RAMTOP-3     ; C l o c k   M o n i t o r   F a i l
FFFE : F8 00    dc. w  mai n             ; Reset

```

Memory Usage

First	Last	Memory	Usage
\$0800	\$0AFF	RAM	== Available for user program ==
\$0B00	\$0BB7	RAM	Monitor Variables and Stack
\$0BB8	\$0BFF	RAM	Redirected Interrupt Vectors
\$F000	\$F7FF	EEPROM	== Available for user program ==
\$F800	\$FFFF	EEPROM	TwinPEEKs Monitor Code