

## COBRA5282 Embedded Processor Module

Product Information 1.5: 2005/01/18

### COBRA5282 Features:

- ColdFire MCF5282 Processor
- 64 MHz Internal Clock
- 4 MByte Flash  
(optional up to 16 MByte)
- 512 kByte Processor Flash
- 8 MByte SDRAM  
(optional up to 32 MByte)
- 10/100 MB Ethernet Interface
- 2x SCI (UART)
- CAN Interface
- QSPI with 4 Chip Selects
- I<sup>2</sup>C Interface
- 8 A/D Channels 10 Bit
- Real Time Clock
- 32-Bit Processor Bus
- Selectable Boot Configuration
- dBUG Debug Monitor
- uClinux Operating System
- 3.3V Operating Voltage



Original Size 58 x 97 mm

### COBRA5282 Interfaces:

#### Standard I/O Interfaces

- Two Rows per 36 Pins (2.54 mm)
- All Processor Ports and Pins are connected to the Standard I/O Interface

#### 32-Bit Processor Bus Interface

- Two 40-Pin Fields (1.27 mm)
- Can be stuffed with various Connector Options

#### Standard BDM Interface

(2x 13 Pins, 2.54 mm)

### Typical Applications:

- Automation
- Industrial Control
- Measurement Equipment
- Data Logging
- Embedded Internet
- CAN to Ethernet Interface
- RS232 to Ethernet Interface
- RS485 to Ethernet Interface
- Education
- Training and Seminars
- Software Development

## COBRA5282 Embedded Processor Module Block Diagram

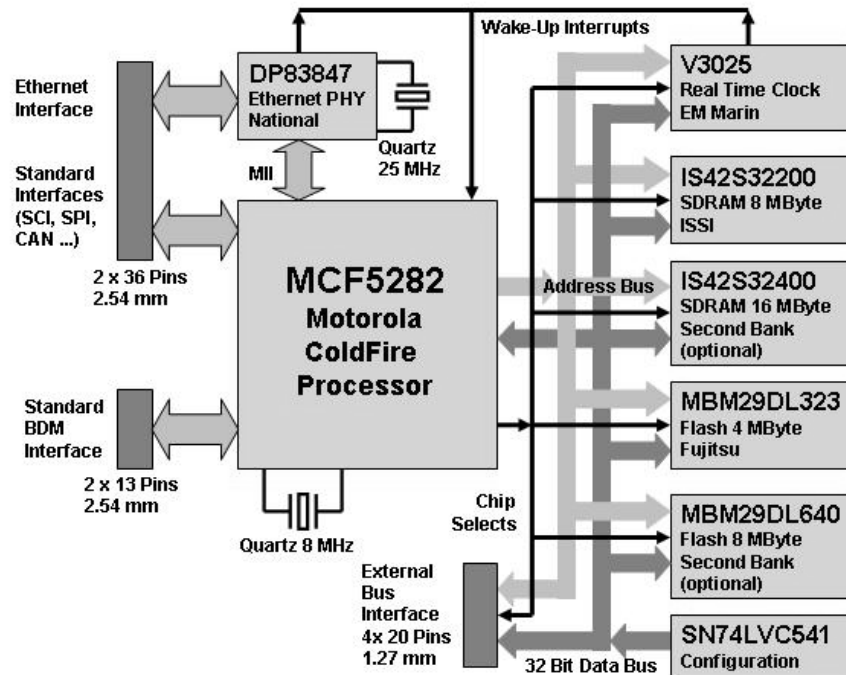

## Connection Options of the COBRA5282 Processor Module

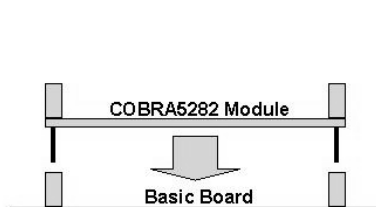

a) COBRA5282 Module is plugged onto the Basic Board

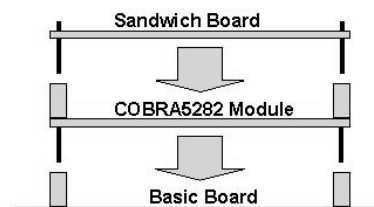

b) Sandwich Board is plugged onto the COBRA5282 Module

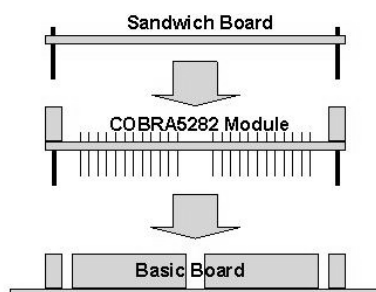

c) Processor Bus of the COBRA5282 Module is plugged on the Basic Board

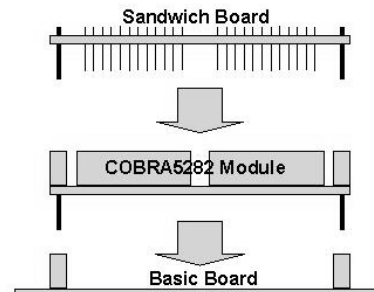

d) Sandwich Board is plugged on the Processor Bus of the COBRA5282 Module

## Carrier Board for the COBRA5282 Processor Module

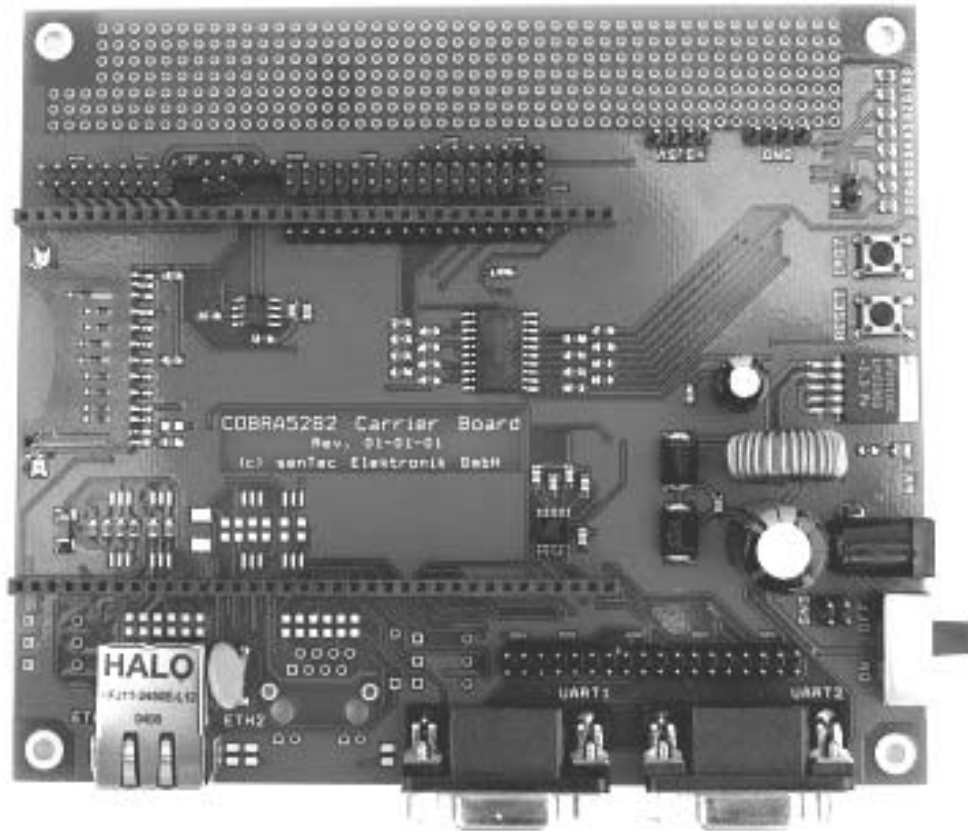

Size approximately 120mm x 110mm

- Carrier Board Features:
- Connectors for the Standard I/O Interfaces of the COBRA5282 Processor Module
  - RJ45 Ethernet Interface
  - Two RS232 Interfaces with Driver
  - CAN Driver and Interface
  - Multi Media Card Interface
  - Interface connectors for SPI, I<sup>2</sup>C
  - Eight driven LEDs
  - Reset Switch
  - Switching Power Supply 6 - 12 V Input

## Starter Kit for the COBRA5282 Processor Module

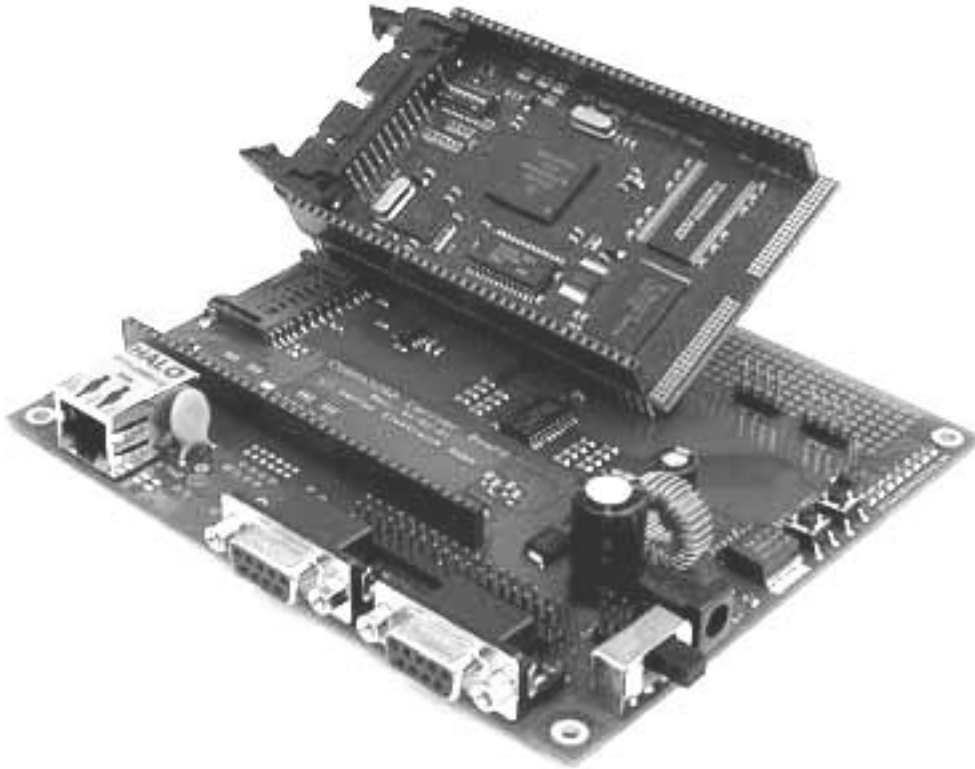

- The Starter Kit contains:
- COBRA5282 Embedded Processor Module
  - Carrier Board for the COBRA5282 Module
  - Documentation on CD

Additional CD with  $\mu$ Clinux distribution and tool chain for software development available as delivery option.

© Copyright senTec Elektronik GmbH 2005. All rights reserved.

senTec Elektronik GmbH  
Ehrenbergstr. 11  
98693 Ilmenau, Germany  
<http://www.sentec-elektronik.de>

Phone: +49 3677 66 83 41  
Fax: +49 3677 66 83 48  
Email: [info@sentec-elektronik.de](mailto:info@sentec-elektronik.de)

Product status: product qualified