



STM32-LCD development board

Users Manual



All boards produced by Olimex are ROHS compliant

Revision Initial, May 2009

Copyright(c) 2009, OLIMEX Ltd, All rights reserved

INTRODUCTION:

STM32-LCD is development prototype board with STM32F103ZE microcontroller from STMicroelectronics. This powerful microcontroller supports various serial interfaces such as USB, USART, SPI. In addition you will find also accelerometer, JTAG, TFT LCD, mini SD/MMC card connector on this board and most of the GPIOs are on extension headers where you can connect your additional circuits. All this allows you to build a diversity of powerful applications to be used in a wide range of situations.

BOARD FEATURES:

- Microcontroller - STM32F103ZE - high-performance ARM® Cortex™-M3 32-bit RISC core operating at a 72 MHz frequency, high-speed embedded memories (Flash memory - 512 Kbytes and SRAM - 64 Kbytes), and an extensive range of enhanced I/Os and peripherals connected to two APB buses.
- JTAG connector
- EXT connector
- UEXT40 connector
- UEXT1 connector
- UEXT2 connector
- EXT_PWR connector
- Mini SD/MMC
- Mini USB
- LCD TFT 320x240 pixels coloured with touch screen
- Power source connector
- Accelerometer
- 8 MHz crystal oscillator
- Reset circuit
- Clock circuit
- PCB: FR-4, 1.5 mm (0,062"), soldermask, silkscreen component print
- Dimensions 79.2x57.6 mm (3.12x2.27")

ELECTROSTATIC WARNING:

The STM32-LCD board is shipped in protective anti-static packaging. The board must not be subject to high electrostatic potentials. General practice for working with static sensitive devices should be applied when working with this board.

BOARD USE REQUIREMENTS:

Cables: The cable you will need depends on the programmer/debugger you use. If you use [ARM-JTAG-EW](#), you will need USB A-B cable.

Hardware: Programmer/Debugger [ARM-JTAG-EW](#) or other compatible programming/debugging tool if you work with EW-ARM.

You can use also [ARM-USB-OCD](#), [ARM-USB-TINY](#), [ARM-JTAG](#). or other compatible programming/debugging tool.

PROCESSOR FEATURES:

STM32-LCD use High-density performance line ARM-based 32-bit MCU with these features:

- Core: ARM 32-bit Cortex™-M3 CPU
 - 72 MHz maximum frequency, 1.25 DMIPS/MHz (Dhrystone 2.1) performance at 0 wait state memory access
 - Single-cycle multiplication and hardware division
- Memories
 - 512 Kbytes of Flash memory
 - 64 Kbytes of SRAM
 - Flexible static memory controller with 4 Chip Select. Supports Compact Flash, SRAM, PSRAM, NOR and NAND memories
 - LCD parallel interface, 8080/6800 modes
- Clock, reset and supply management
 - 2.0 to 3.6 V application supply and I/Os
 - POR, PDR, and programmable voltage detector (PVD)
 - 4-to-16 MHz crystal oscillator
 - Internal 8 MHz factory-trimmed RC
 - Internal 40 kHz RC with calibration
 - 32 kHz oscillator for RTC with calibration
- Low power
 - Sleep, Stop and Standby modes
 - VBAT supply for RTC and backup registers
- 3 × 12-bit, 1 μs A/D converters (up to 21 channels)

- Conversion range: 0 to 3.6 V
 - Triple-sample and hold capability
 - Temperature sensor
- 2 × 12-bit D/A converters
- DMA: 12-channel DMA controller
 - Supported peripherals: timers, ADCs, DAC, SDIO, I²Ss, SPIs, I²Cs and USARTs
- Debug mode
 - Serial wire debug (SWD) & JTAG interfaces
 - Cortex-M3 Embedded Trace Macrocell™
- 112 fast I/O ports
 - 112 I/Os, all mappable on 16 external interrupt vectors, all 5 V-tolerant except for analog inputs
- 11 timers
 - four 16-bit timers, each with up to 4 IC/OC/PWM or pulse counter and quadrature (incremental) encoder input
 - 2 × 16-bit motor control PWM timers with dead-time generation and emergency stop
 - 2 × watchdog timers (Independent and Window)
 - SysTick timer: a 24-bit downcounter
 - 2 × 16-bit basic timers to drive the DAC
- 13 communication interfaces
 - 2 × I²C interfaces (SMBus/PMBus)
 - 5 USARTs (ISO 7816 interface, LIN, IrDA capability, modem control)
 - 3 SPIs (18 Mbit/s), 2 with I²S interface multiplexed
 - CAN interface (2.0B Active)
 - USB 2.0 full speed interface
 - SDIO interface
- CRC calculation unit, 96-bit unique ID

BLOCK DIAGRAM:

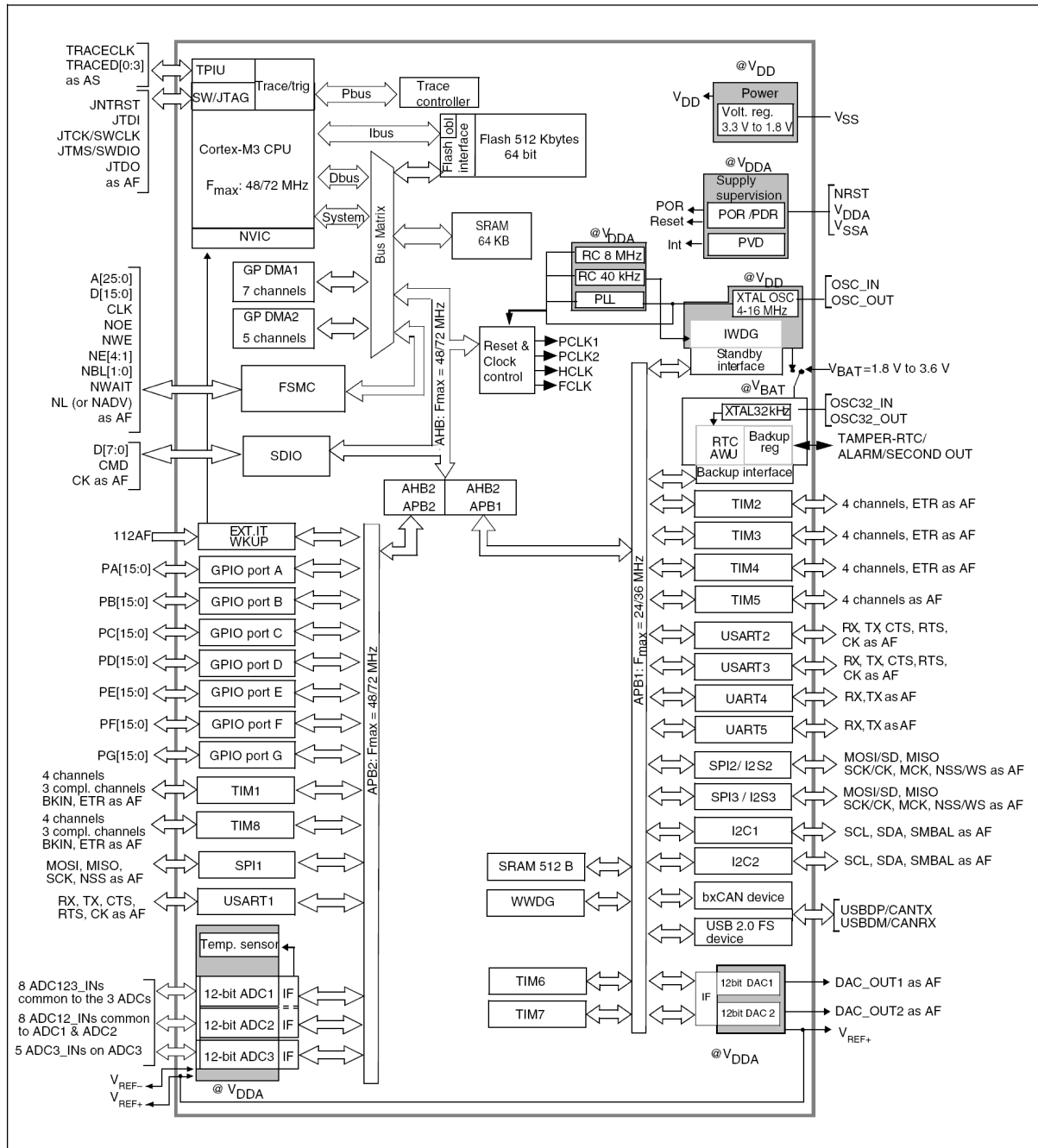

1. AF = alternate function on I/O port pin.

MEMORY MAP:

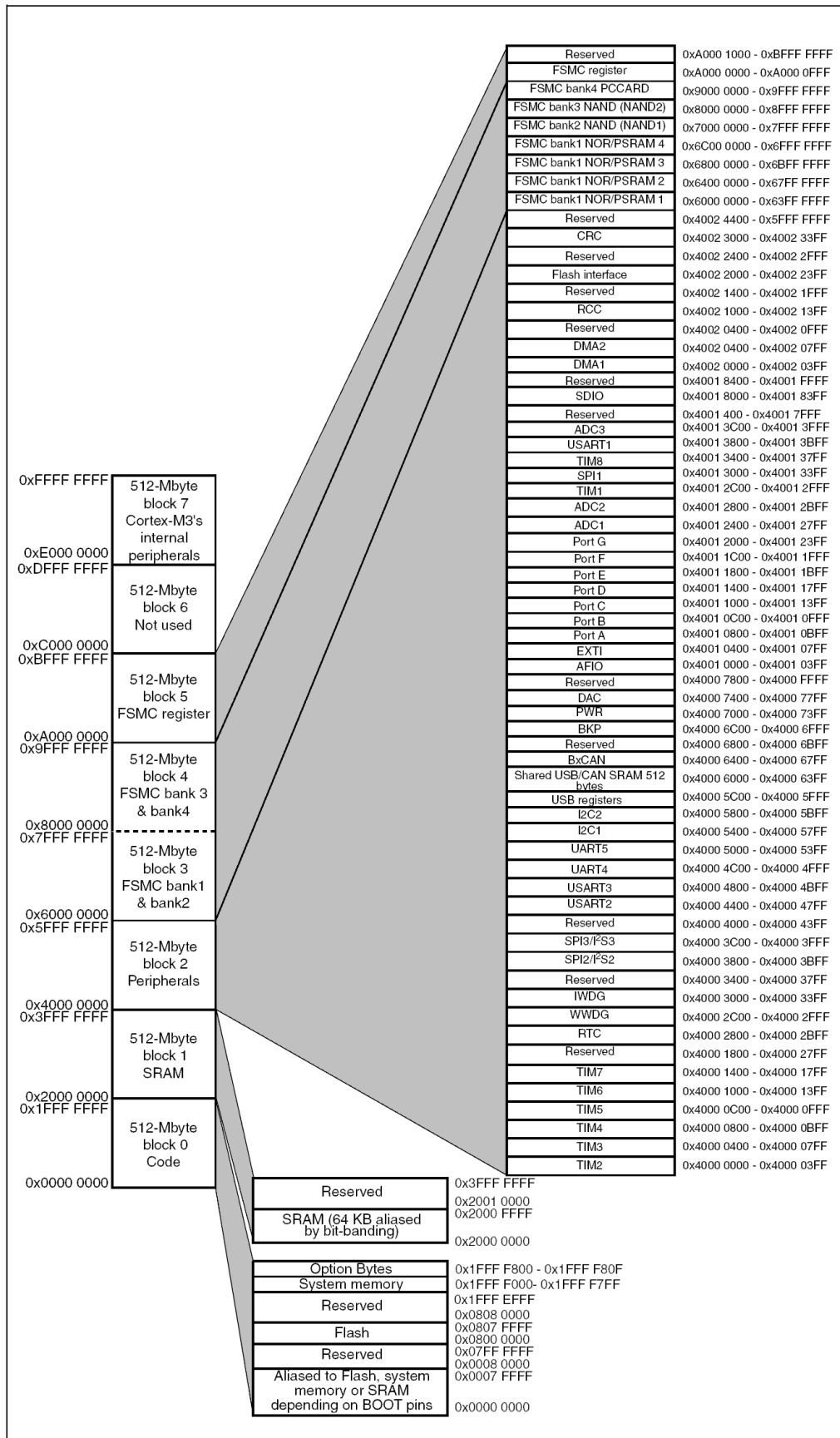

SCHEMATIC:

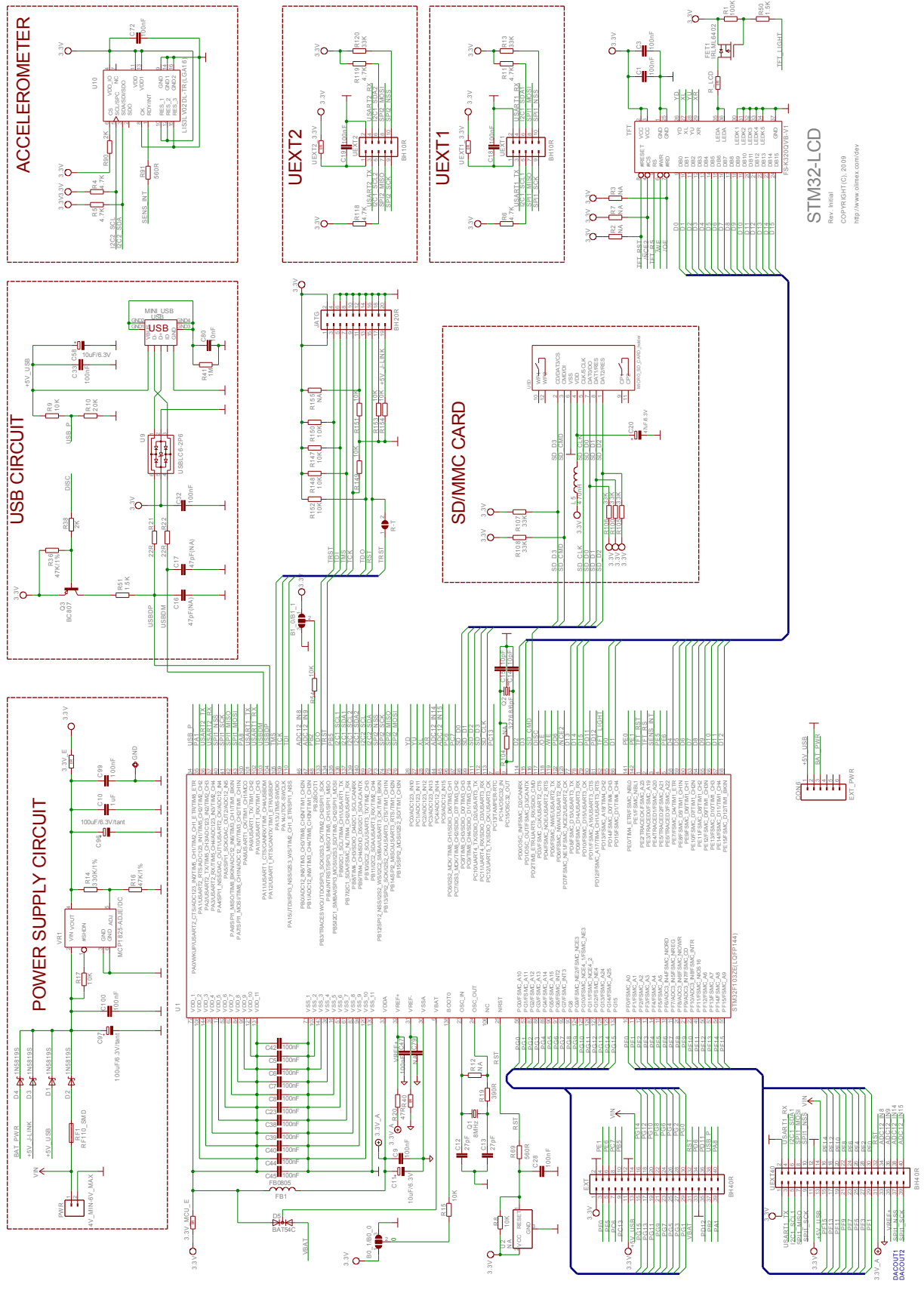

BOARD LAYOUT

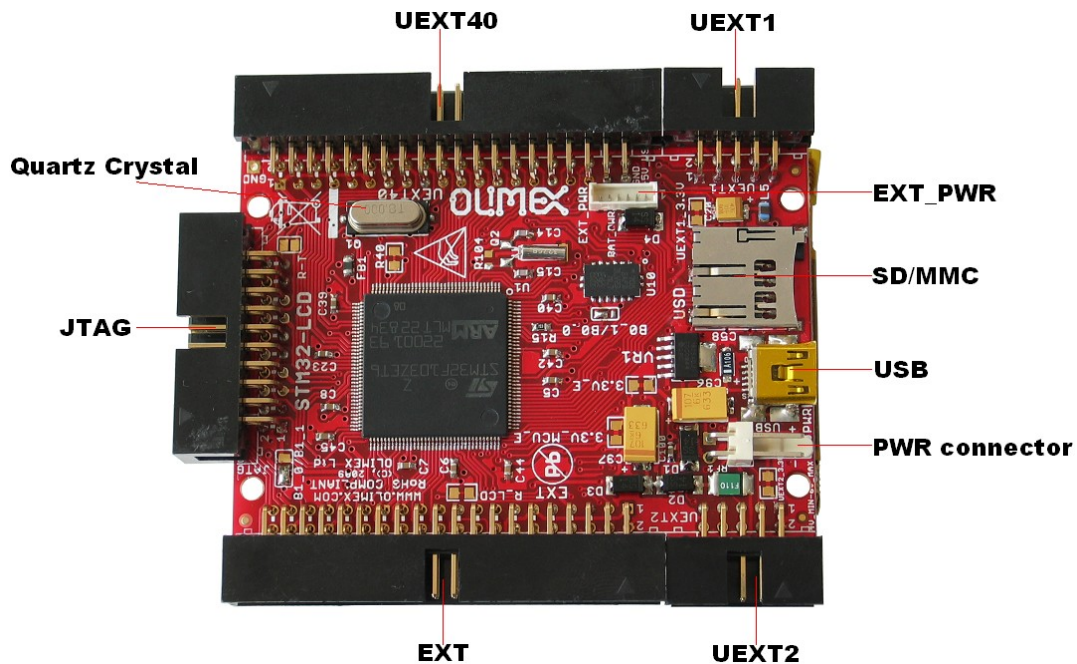

POWER SUPPLY CIRCUIT:

STM32-LCD can take power from four sources:

- Power connector - 4V - 6V DC.
- BAT_PWR from EXT_PWR - 4V DC.
- +5V_J-LINK from JTAG connector
- +5V_USB from USB connector

The programmed board power consumption is about 200 mA.

RESET CIRCUIT:

STM32-LCD reset circuit includes R8 (10k), R69 (560 Ohm), C28 (100nF) pin 15 of JTAG connector, EXT pin 32, UEXT40 pin 32 and STM32F103ZE pin 25 (NRST).

CLOCK CIRCUIT:

Quartz crystal 8 MHz is connected to STM32F103ZE pin 23 (OSC_IN) and pin 24 (OSC_OUT).

Quartz crystal 32.768 kHz is connected to STM32F103ZE pin 8 (PC14/OSC32_IN) and pin 9 (PC15/OSC32_OUT).

JUMPER DESCRIPTION:

R-T



Connect RST with TRST.

Default state is open.

UEXT1_3.3V



This jumper when closed, supplies 3.3 V voltage to UEXT1 pin 1.

Default state is closed.

UEXT2_3.3V



This jumper when closed, supplies 3.3 V voltage to UEXT2 pin 1.

Default state is closed.

3.3V_E



This jumper, when closed, enable the main 3.3 V regulator VR1 - MCP1825-ADJE/DC.

Default state is closed.

3.3V_MCU_E



This jumper, when closed, enables STM32F103ZE 3.3 V power supply.

Default state is closed.

R_LCD



You can use this jumper, when it's open, to measure the current of LCD backlight.

Default state is closed.

B0_1/B0_0



Select BOOT0 Boot mode.

Default state is in position B0_0.

B1_0/B1_1



Select BOOT1 Boot mode.

Default state - B1_0 - not shorted and B1_1 - not shorted.

Boot mode selection pins		Boot Mode	Aliasing
BOOT1	BOOT0		
x	0	Main Flash memory	Main Flash memory is selected as boot space
0	1	System memory	System memory is selected as boot space
1	1	Embedded SRAM	Embedded SRAM is selected as boot space

INPUT/OUTPUT:

- LCD TFT 320x240 pixels coloured with touch screen.

EXTERNAL CONNECTORS DESCRIPTION:

UEXT1

Pin #	Signal Name
1	3.3V
2	GND
3	USART1_TX
4	USART1_RX
5	I2C1_SCL1
6	I2C1_SDA1
7	SPI1_MISO
8	SPI1_MOSI
9	SPI1_SCK
10	SPI1_NSS

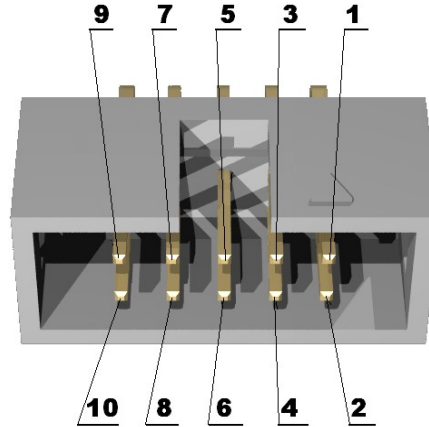

UEXT2

Pin #	Signal Name
1	3.3V
2	GND
3	USART2_TX
4	USART2_RX
5	I2C1_SCL2
6	I2C1_SDA2
7	SPI2_MISO
8	SPI2_MOSI
9	SPI2_SCK
10	SPI2_NSS

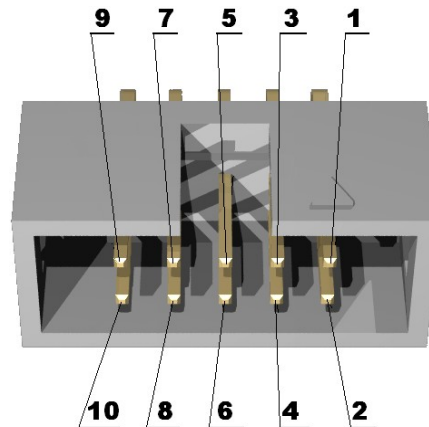

EXT

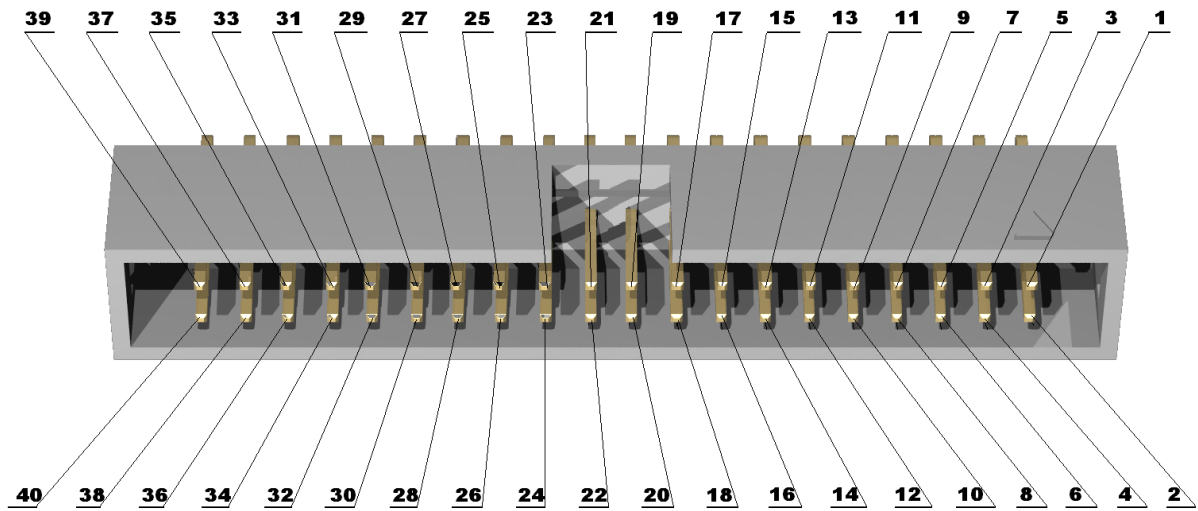

Pin #	Signal Name	Pin #	Signal Name
1	3.3 V	2	GND
3	PE0	4	PE1
5	PE5	6	PE6
7	PC6	8	PC7
9	PC13	10	PB5
11	3.3 V	12	GND
13	+5V_USB	14	VIN
15	PG15	16	PG14
17	PG13	18	PG12
19	PG11	20	PG10
21	PG9	22	PG8
23	PG7	24	PG6
25	PG5	26	PG4
27	PG3	28	PG2
29	PG1	30	PG0
31	VBAT	32	RST
33	GND	34	PD6
35	PD12	36	PD11
37	PB2	38	USB_P
39	PA1	40	PA8

UEXT40

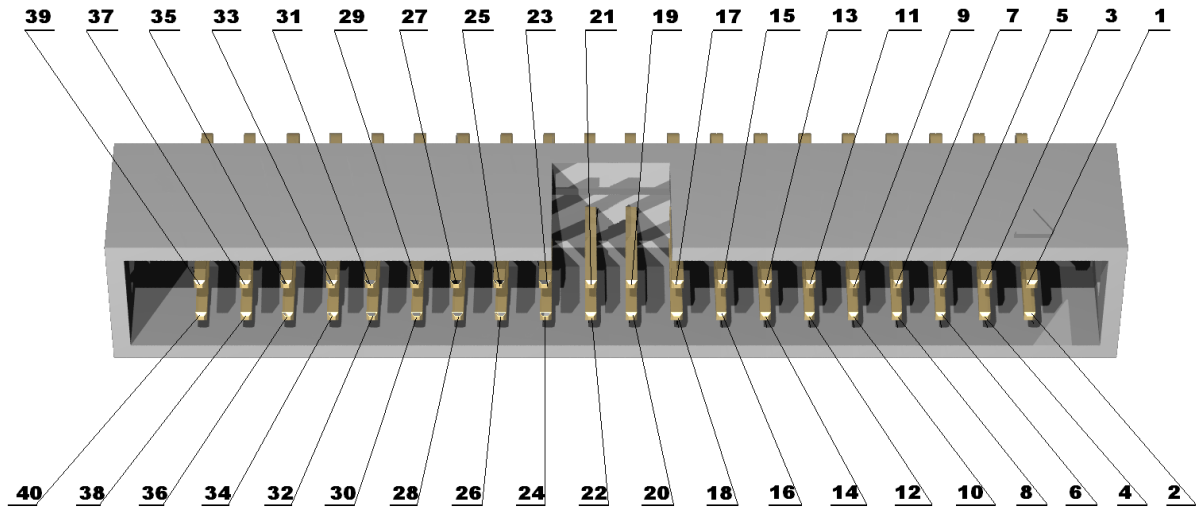

Pin #	Signal Name	Pin #	Signal Name
1	3.3 V	2	GND
3	USART1_TX	4	USART1_RX
5	I2C1_SCL1	6	I2C1_SDA1
7	SPI1_MISO	8	SPI1_MOSI
9	SPI1_SCK	10	SPI1_NSS
11	3.3 V	12	GND
13	+5V_USB	14	VIN
15	PF15	16	PF14
17	PF13	18	PF12
19	PF11	20	PF10
21	PF9	22	PF8
23	PF7	24	PF6
25	PF5	26	PF4
27	PF3	28	PF2
29	PF1	30	PF0
31	3.3V_A	32	RST
33	AGND	34	ADC12_IN8
35	VREF+	36	ADC12_IN9
37	SPI1_NSS	38	ADC12_IN14
39	SPI1_SCK	40	ADC12_IN15

JTAG:

The JTAG connector allows the software debugger to talk via a JTAG (Joint Test Action Group) port directly to the core. Instructions may be inserted and executed by the core thus allowing STM32F103ZE memory to be programmed with code and executed step by step by the host software.

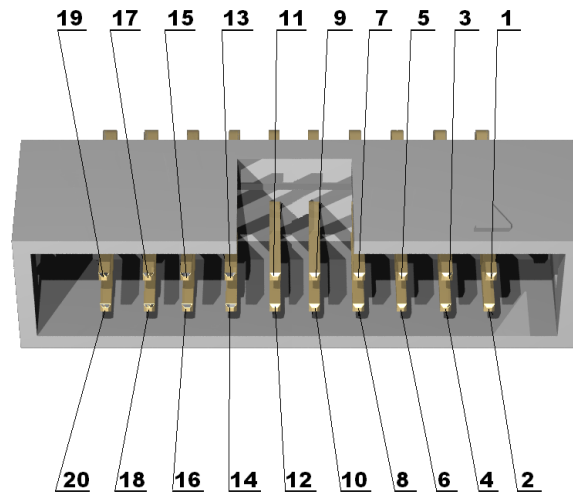

Pin #	Signal Name	Pin #	Signal Name
1	3.3V	2	3.3V
3	TRST	4	GND
5	TDI	6	GND
7	TMS	8	GND
9	TCK	10	GND
11	pull-down	12	GND
13	TDO	14	GND
15	RST	16	GND
17	pull-down	18	GND
19	+5V J-LINK	20	GND

USB

Pin #	Signal Name
1	+5V_USB
2	USBDM
3	USBDP
4	NC
5	GND

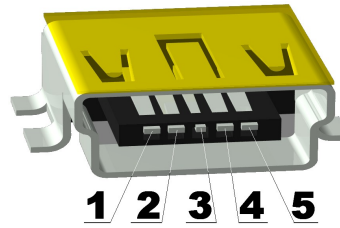

PWR

Pin #	Signal Name
1	VIN (4 - 6) V DC
2	GND

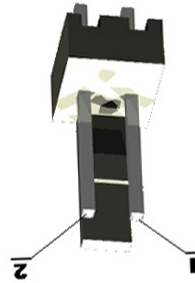

SD/MMC

Pin #	Signal Name
1	SD_D2
2	SD_D3
3	SD_CMD
4	VDD (3.3V)
5	SD_CLK
6	GND
7	SD_D0
8	SD_D1
9	Not connected
10	Not connected
11	Not connected
12	Not connected

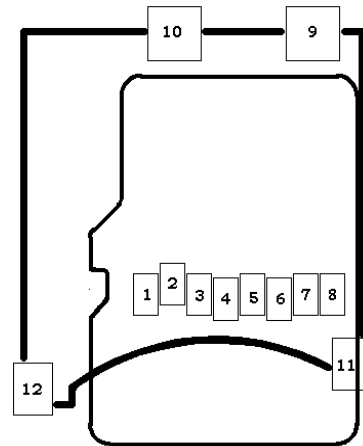

SPI

Up to three SPIs are able to communicate up to 18 Mbits/s in slave and master modes in full-duplex and simplex communication modes. The 3-bit prescaler gives 8 master mode frequencies and the frame is configurable to 8 bits or 16 bits. The hardware CRC generation/verification supports basic SD Card/MMC modes.

All SPIs can be served by the DMA controller.

I²S

Two standard I²S interfaces (multiplexed with SPI2 and SPI3) are available, that can be operated in master or slave mode. These interfaces can be configured to operate with 16/32 bit resolution, as input or output channels. Audio sampling frequencies from 8 kHz up to 48 kHz are supported. When either or both of the I²S interfaces is/are configured in master mode, the master clock can be output to the external DAC/CODEC at 256 times the sampling frequency.

I²C

Up to two I²C bus interfaces can operate in multimaster and slave modes. They can support standard and fast modes.

They support 7/10-bit addressing mode and 7-bit dual addressing mode (as slave). A hardware CRC generation/verification is embedded.

They can be served by DMA and they support SMBus 2.0/PMBus.

MECHANICAL DIMENSIONS

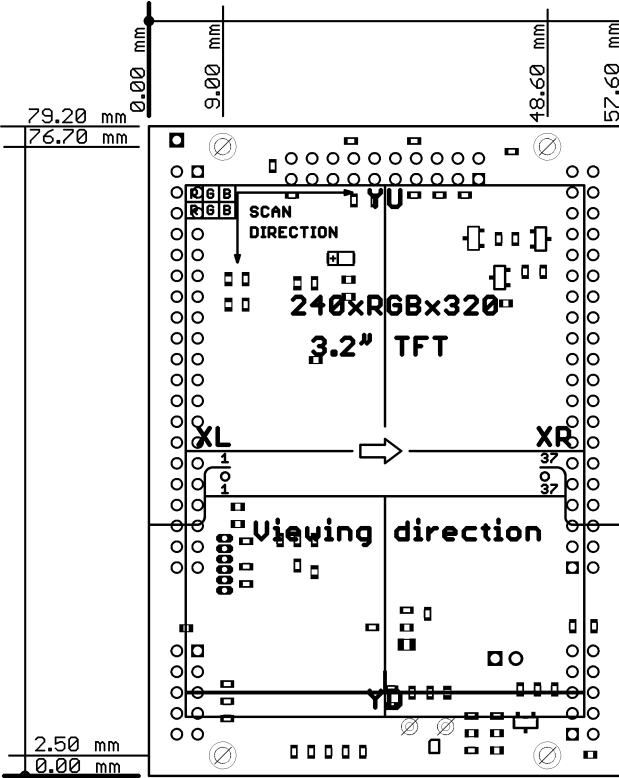

AVAILABLE DEMO SOFTWARE

- STM32-LCD-DEMO

ORDER CODE: STM32-LCD - assembled and tested board

How to order?

You can order to us directly or by any of our distributors.
Check our web www.olimex.com/dev for more info.

Revision history:

Revision Initial, May 2009

Disclaimer:

© 2009 Olimex Ltd. All rights reserved. Olimex®, logo and combinations thereof, are registered trademarks of Olimex Ltd. Other terms and product names may be trademarks of others.

The information in this document is provided in connection with Olimex products. No license, express or implied or otherwise, to any intellectual property right is granted by this document or in connection with the sale of Olimex products.

Neither the whole nor any part of the information contained in or the product described in this document may be adapted or reproduced in any material from except with the prior written permission of the copyright holder.

The product described in this document is subject to continuous development and improvements. All particulars of the product and its use contained in this document are given by OLIMEX in good faith. However all warranties implied or expressed including but not limited to implied warranties of merchantability or fitness for purpose are excluded.

This document is intended only to assist the reader in the use of the product. OLIMEX Ltd. shall not be liable for any loss or damage arising from the use of any information in this document or any error or omission in such information or any incorrect use of the product.